



Product manual

invt Frequency inverter
GD20-EU Series



invt - GD20-EU

This operating instruction is to be read carefully and kept at the place of the device.



Contents

Contents	i
Chapter 1 Safety precautions	1
1.1 Safety definition	1
1.2 Warning symbols	1
1.3 Safety guide	2
1.3.1 Delivery and installation	2
1.3.2 Commissioning and running	3
1.3.3 Maintenance and component replacement	3
1.3.4 What to do after scrapping	4
Chapter 2 Product overview	5
2.1 Quick startup	5
2.1.1 Unpacking inspection	5
2.1.2 Checking before applying	5
2.1.3 Environment confirmation	5
2.1.4 Installation confirmation	6
2.1.5 Basic commissioning	6
2.2 Data related to safety standards	7
2.3 Decommissioning	7
2.4 Product specification	7
2.5 Product nameplate	9
2.6 Model code	10
2.7 Rated specifications	10
2.8 Structure diagram	12
Chapter 3 Installation guidelines	14
3.1 Mechanical installation	14
3.1.1 Installation environment	14
3.1.2 Installation direction	15
3.1.3 Installation mode	15
3.2 Standard wiring	17
3.2.1 Wiring of main circuit	17
3.2.2 Main circuit terminals	18
3.2.3 Wiring of main circuit terminals	19
3.2.4 Wiring of control circuit	19
3.2.5 Control circuit terminals	20
3.2.6 Input/output signal connection figure	22
3.3 Overview of STO function	23
3.3.1 Logic table for STO function	24
3.3.2 Description of STO channel delay	24

3.3.3 STO function installation checklist	25
3.4 Layout protection	25
3.4.1 Protecting the VFD and input power cable in short-circuit situations	25
3.4.2 Protect the motor and motor cables.....	26
3.4.3 Implementing a bypass connection	26
Chapter 4 Keypad operation.....	27
4.1 Keypad introduction.....	27
4.2 Keypad display	30
4.2.1 Displaying stopped-state parameters	30
4.2.2 Displaying running-state parameters	30
4.2.3 Displaying fault information.....	30
4.2.4 Editing function codes.....	31
4.3 Operations on the keypad	31
4.3.1 Modifying VFD function codes	31
4.3.2 Setting a password for the VFD.....	32
4.3.3 Viewing VFD status.....	32
Chapter 5 Function parameters	33
P00 group Basic functions	33
P01 group Start and stop control	40
P02 group Motor 1 parameters.....	46
P03 group Vector control	49
P04 group SVPWM control.....	53
P05 group Input terminals	57
P06 group Output terminals.....	64
P07 group HMI.....	67
P08 group Enhanced functions	74
P09 group PID control	83
P10 group Simple PLC and multi-step speed control.....	88
P11 group Protection parameters	91
P13 group SM control	95
P14 group Serial communication.....	96
P17 group Status viewing	98
P18 group Functions for PTC temperature detection.....	101
Chapter 6 Fault tracking	103
6.1 Fault prevention.....	103
6.1.1 Periodical maintenance	103
6.1.2 Cooling fan.....	106
6.1.3 Capacitor.....	107
6.1.4 Power cable	108
6.2 Fault solution	108
6.2.1 Indications of alarms and faults	108

6.2.2 Fault reset	108
6.2.3 VFD faults and solutions	108
6.2.4 Other states	115
Chapter 7 Communication protocol	116
7.1 Modbus protocol introduction	116
7.2 Application	116
7.2.1 Two-wire RS485.....	116
7.2.2 RTU mode.....	119
7.2.3 ASCII mode.....	122
7.3 RTU command code and communication data	123
7.3.1 RTU mode.....	123
7.3.2 ASCII mode.....	127
7.4 Data address definition.....	130
7.4.1 Function code address format rules	130
7.4.2 Description of other function addresses in Modbus.....	131
7.4.3 Fieldbus scale.....	135
7.4.4 Error message response	135
7.5 Read/Write operation example	137
7.5.1 Examples of reading command 03H.....	137
7.5.2 Examples of write command 06H	138
7.5.3 Examples of continuously writing command 10H	140
7.6 Common communication faults	142
Appendix A Technical data	143
A.1 Derated application	143
A.1.1 Capacity.....	143
A.1.2 Derating.....	143
A.1.3 Power consumption.....	144
A.2 CE	145
A.2.1 CE marking.....	145
A.2.2 Compliance with the European EMC Directive	145
A.3 EMC regulations.....	145
A.3.1 VFDs of category C2	146
A.3.2 VFDs of category C3	146
A.4 Motor connection data.....	146
Appendix B Dimension drawings	148
B.1 External keypad structure	148
B.2 VFD chart	149
Appendix C Optional peripheral accessories	154
C.1 Wiring of peripheral accessories.....	154
C.2 Power supply	155
C.3 Cables.....	156

C.3.1 Power cables.....	156
C.3.2 Control cables	156
C.4 Breaker and electromagnetic contactor	157
C.5 Reactors.....	158
C.6 Filter	160
C.6.1 C3 Filter model instruction	160
C.6.2 C3 filter	160
C.6.3 Installation instruction for C3 filter	162
C.6.4 C2 Filter type instruction	162
C.6.5 C2 filter model selection	163
C.7 Braking resistors	164
C.7.1 Selecting braking resistors	164
C.7.2 Braking resistor installation	165
Appendix D Energy efficiency data	167
Appendix E Further information	169
D.1 Product and service inquiries.....	169
D.2 Feedback on INVT VFD manuals	169
D.3 Documents on the Internet.....	169

Chapter 1 Safety precautions

Please read this manual carefully and follow all safety precautions before moving, installing, operating and servicing the variable-frequency drive (VFD). If ignored, physical injury or death may occur, or damage may occur to the devices.









If any physical injury or death or damage to the devices occurs for ignoring to the safety precautions in the manual, our company will not be responsible for any damages and we are not legally bound in any manner.





1.1 Safety definition

Danger:	Serious physical injury or even death may occur if not follow relevant requirements.
Warning:	Physical injury or damage to the devices may occur if not follow relevant requirements.
Note:	Physical hurt may occur if not follow relevant requirements.
Qualified electricians:	People working on the device should take part in professional electrical and safety training, receive the certification and be familiar with all steps and requirements of installing, commissioning, operating and maintaining the device to avoid any emergency.





1.2 Warning symbols

Warnings caution you about conditions which can result in serious injury or death and/or damage to the equipment, and advice on how to avoid the danger. The following warning symbols are used in this manual:

Symbol	Name	Instruction	Abbreviation
 Danger	Danger	Serious physical injury or even death may occur if related requirements are not followed.	
 Warning	Warning	Physical injury or damage to the devices may occur if related requirements are not followed.	
 Forbid	Electrostatic discharge	The PCBA may be damaged if related requirements are not followed.	
 Hot	Hot sides	The VFD base may become hot. Do not touch.	

Symbol	Name	Instruction	Abbreviation
	Electric shock	As high voltage still presents in the bus capacitor after power off, wait for at least five minutes (or 15min/25min, depending on the warning symbols on the machine) after power off to prevent electric shock.	
	Read manual	Read the operation manual before operating on the equipment.	
Note	Note	Actions taken to ensure proper operation.	Note

1.3 Safety guide

	<ul style="list-style-type: none"> ◇ Only qualified electricians are allowed to operate on the VFD. ◇ Do not carry out any wiring, inspection or component replacement when the power supply is applied. Ensure all input power supply is disconnected before wiring and checking and always wait for at least the time designated on the VFD or until the DC bus voltage is less than 36V. The table below describes the waiting time: 											
	<table border="1" style="width: 100%; border-collapse: collapse;"> <thead> <tr> <th colspan="2">VFD model</th> <th>Minimum waiting time</th> </tr> </thead> <tbody> <tr> <td>1PH 230V</td> <td>0.4kW–2.2kW</td> <td>5 minutes</td> </tr> <tr> <td>3PH 230V</td> <td>0.4kW–7.5kW</td> <td>5 minutes</td> </tr> <tr> <td>3PH 400V</td> <td>0.75kW–110kW</td> <td>5 minutes</td> </tr> </tbody> </table>	VFD model		Minimum waiting time	1PH 230V	0.4kW–2.2kW	5 minutes	3PH 230V	0.4kW–7.5kW	5 minutes	3PH 400V	0.75kW–110kW
VFD model		Minimum waiting time										
1PH 230V	0.4kW–2.2kW	5 minutes										
3PH 230V	0.4kW–7.5kW	5 minutes										
3PH 400V	0.75kW–110kW	5 minutes										
	◇ Do not refit the VFD unless authorized; otherwise, fire, electric shock or other injury may occur.											
	◇ The base of the radiator may become hot during running. Do not touch to avoid hurt.											
	◇ The electrical parts and components inside the VFD are electrostatic. Take measurements to avoid electrostatic discharge during related operation.											

1.3.1 Delivery and installation

	<ul style="list-style-type: none"> ◇ Please install the VFD on fire-retardant material and keep the VFD away from combustible materials. ◇ Connect the optional brake parts (braking resistors, braking units or feedback units) according to the wiring diagram. ◇ Do not operate on the VFD if there is any damage or components loss to the VFD. ◇ Do not touch the VFD with wet items or body; otherwise, electric shock may occur.
--	---

Note:

- ◇ Select appropriate moving and installing tools to ensure a safe and normal running of the VFD and avoid physical injury or death. For physical safety, the erector should take some mechanical protective measurements, such as wearing exposure shoes and working uniforms.
- ◇ Ensure to avoid physical shock or vibration during delivery and installation.
- ◇ Do not carry the VFD by its cover. The cover may fall off.
- ◇ Install away from children and other public places.
- ◇ The leakage current of the VFD may be above 3.5mA during operation. Ground properly and ensure the grounding resistor is less than 10Ω. The conductivity of PE grounding conductor is the same as that of the phase conductor.
- ◇ R, S and T are the input terminals of the power supply, while U, V and W are the motor terminals. Please connect the input power cables and motor cables properly; otherwise, the damage to the VFD may occur.

1.3.2 Commissioning and running

	<ul style="list-style-type: none"> ◇ Disconnect all power supplies applied to the VFD before the terminal wiring and wait for at least the designated time after disconnecting the power supply. ◇ High voltage is present inside the VFD during running. Do not carry out any operation except for the keypad setting. ◇ The VFD may start up by itself when P01.21=1. Do not get close to the VFD and motor. ◇ The VFD cannot be used as "Emergency-stop device". ◇ The VFD cannot be used to brake the motor suddenly. A mechanical brake device should be provided.
--	--

Note:

- ◇ Do not switch on or off the input power supply of the VFD frequently.
- ◇ For VFDs that have been stored for a long time, set the capacitance and carry out inspection and pilot run on the VFD before use.
- ◇ Close the front cover before running; otherwise, electric shock may occur.

1.3.3 Maintenance and component replacement



	<ul style="list-style-type: none"> ◇ Only well-trained and qualified professionals are allowed to carry out maintenance, inspection, and component replacement on the VFD. ◇ Disconnect all the power sources applied to the VFD before terminal wiring, and wait for at least the time designated on the VFD after
--	---

	<p>disconnecting the power sources.</p> <ul style="list-style-type: none"> ✧ Take measures to prevent screws, cables and other conductive matters from falling into the VFD during maintenance and component replacement.
--	--

Note:

- ✧ Select proper torque to tighten screws.
- ✧ Keep the VFD and its parts and components away from combustible materials during maintenance and component replacement.
- ✧ Do not carry out insulation voltage-endurance test on the VFD, or measure the control circuits of the VFD with megameters.

1.3.4 What to do after scrapping

	<ul style="list-style-type: none"> ✧ The heavy metals inside the VFD should be treated as industrial effluent.
	<ul style="list-style-type: none"> ✧ When the life cycle ends, the product should enter the recycling system. Dispose of it separately at an appropriate collection point instead of placing it in the normal waste stream.

Chapter 2 Product overview

2.1 Quick startup

2.1.1 Unpacking inspection

Check the following items after receiving the product.

1. Whether the packing box is damaged or dampened.
2. Whether the model identifier on the exterior surface of the packing box is consistent with the purchased model.
3. Whether the interior surface of the packing box is abnormal, for example, in wet condition, or whether the enclosure of the product is damaged or cracked.
4. Whether the nameplate of the product is consistent with the model identifier on the exterior surface of the packing box.
5. Whether the accessories (including the user manual and control keypad) inside the packing box are complete.

If any of the problems described in the check items are found, contact the local dealer or our company.

2.1.2 Checking before applying

Confirm the following items before using the VFD.

1. Mechanical type of the load to be driven by the VFD. Check whether the VFD will be overloaded in actual operation and whether the power level needs to be raised.
2. Whether the actual running current of the to-be-loaded motor is lower than the rated current of the VFD.
3. Whether control precision implemented by the VFD meets the requirement of the actual load.
4. Whether the grid voltage is consistent with the rated voltage of the VFD.

2.1.3 Environment confirmation

Check the following items before you install and use the VFD.

1. Whether the ambient temperature in the application is higher than 40°C. If yes, derate the machine by 1% for every increased 1°C. Do not use the VFD in environments where the temperature is higher than 50°C. Note: If the VFD is installed in a cabinet, the ambient temperature is the air temperature inside the cabinet.
2. Whether the ambient temperature in application is lower than -10°C. If yes, configure a heating device. Note: If the VFD is installed in a cabinet, the ambient temperature is the air temperature inside the cabinet.

3. When the altitude exceeds 3000m, consult the local INVT dealer or office for details. When the altitude exceeds 1000m, derate by 1% for every increase of 100m.
4. Whether the ambient humidity is higher than 90% or condensation occurs. If yes, take extra protective measures.
5. Whether there is direct sunlight or biological invasion in the application environment. If yes, take extra protective measures.
6. Whether there is dust or inflammable and explosive gas in the application environment. If yes, take extra protective measures.

2.1.4 Installation confirmation

Check the following items after the installation of the VFD is complete.

1. Whether the input power cables and motor cables meet the current-carrying capacity requirements of the actual load.
2. Whether the peripheral accessories are correctly selected and properly installed, and whether the installation cables meet the current-carrying capacity requirements of the accessories, including the input reactor, input filter, output reactor, output filter, DC reactor, braking unit, and braking resistor.
3. Whether the VFD is installed on non-flammable materials, and whether its heat-emitting accessories (such as reactor and braking resistor) are kept away from inflammable materials.
4. Whether all the control cables are wired separately from power cables, and whether electromagnetic compatibility (EMC) specification requirements are taken into full account during the wiring.
5. Whether all the grounding systems are properly grounded according to the requirements of the VFD.
6. Whether all the installation spacings of the VFD meet the requirements stated in the manual.
7. Whether the installation of the VFD meets the requirements stated in the manual.
8. Check that the external connection terminals are tightly fastened and whether the torque meets the requirements.
9. Whether screws, cables, or other conductive items drop into the VFD. If yes, take them out.

2.1.5 Basic commissioning

Complete the basic commissioning as follows before using the VFD.

1. Perform autotuning if required. Remove the motor load, if possible, to perform dynamic parameter autotuning; and if the load cannot be removed, you can perform static autotuning.
2. Adjust the ACC/DEC time according to the actual operation conditions of the load.

3. Perform commissioning on the machine in jogging mode and check whether the rotating direction of the motor meets the requirement. If no, exchange the wires of any two phases of the motor to change the running direction of the motor.
4. Set all control parameters and then run the machine.

2.2 Data related to safety standards

IEC/EN 61508 (type A system)							ISO 13849**			
SIL	PFH	HFT	SFF	λ_{du}	λ_{dd}	PTI*	PL	CCF	DC	Category
2	8.73×10^{-10}	1	71.23%	1.79×10^{-9}	0	1 year	d	57	60%	3
3	8.53×10^{-10}	1	99.38%	0.64×10^{-10}	3.3×10^{-9}	3 months	e	57	98.09%	3

* PTI: proof test interval.

** According to the categorization defined in EN ISO 13849-1.

2.3 Decommissioning

Before decommissioning any safety system from active service:

- ◇ Evaluate the impact of decommissioning on adjacent operating units and facilities or other field services.
- ◇ Conduct a proper review and obtain required authorization.
- ◇ Ensure that the safety functions remain appropriate during decommissioning activities.
- ◇ Implement appropriate change management procedures for all decommissioning activities.

2.4 Product specification

Function		Specification
Power input	Input voltage (V)	AC 1PH 200V–240V, rated voltage: 230V AC 3PH 200V–240V, rated voltage: 230V AC 3PH 380V–480V, rated voltage: 400V
	Allowable voltage fluctuation	-15%–+10%
	Input current (A)	Refer to section 2.7 "Rated specifications".
	Input frequency (Hz)	50Hz or 60Hz; allowed range: 47–63Hz
Power output	Output voltage (V)	0–input voltage
	Output current (A)	Refer to section 2.7 "Rated specifications".
	Output power (kW)	Refer to section 2.7 "Rated specifications".
	Output frequency (Hz)	0–400Hz
Technical control feature	Control mode	SVPWM, SVC
	Motor	Asynchronous motor
	Adjustable-speed ratio	Asynchronous motor 1:100 (SVC)
	Speed control accuracy	$\pm 0.2\%$ (SVC)
	Speed fluctuation	$\pm 0.3\%$ (SVC)

Function		Specification
	Torque response	<20ms (SVC)
	Torque control accuracy	10%
	Starting torque	0. 5Hz/150% (SVC)
	Overload capability	150% of rated current: 1 minute 180% of rated current: 10 seconds 200% of rated current: 1 second
Running control feature	Frequency setting method	Digital setting, analog setting, pulse frequency setting, multi-step speed running setting, simple PLC setting, PID setting, Modbus communication setting Shift between the set combination and set channel.
	Auto-adjustment of the voltage	Keep a stable voltage automatically when the grid voltage transients
	Fault protection	Provide comprehensive fault protection functions: overcurrent, overvoltage, undervoltage, overheating, phase loss and overload, etc.
	Start after speed tracking	Smoothing starting for running motor
Peripheral interface	Analog input	1 (AI2) 0–10V/0–20mA and 1 (AI3) -10–10V
	Analog output	2 (AO1, AO2) 0–10V/0–20mA. * AO2 output only available on GD20-EU >2.2kW
	Digital input	4 common inputs, the max. frequency: 1kHz; 1 high speed input, the max. frequency: 50kHz
	Digital output	1 Y1 terminal output
	Relay output	2 programmable relay outputs RO1A NO, RO1B NC, RO1C common terminal RO2A NO, RO2B NC, RO2C common terminal Contact capacity: 3A/AC250V, 1A/DC30V *Relay 2 output only available on GD20-EU > 2.2kW
Others	DC reactor	Standard embedded DC reactor for the VFDs (≥18.5kW)
	Installation mode	Wall and rail installation of the VFDs (single phase 230V/three phase 400V, ≤2.2KW and three phase 230V, ≤0.75KW) Wall and flange installation of the VFDs (three phase 400V, ≥4KW and three phase 230V, ≥1.5KW)
	Braking unit	Standard for the VFDs≤37kW and optional for the VFDs within 45–110kW
	EMI filter	3PH 400V 4kW and above/3PH 230V 1.5kW and above can comply with IEC 61800-3 class C3, others can meet requirements of IEC 61800-3 class

Function	Specification
	C3 by installing external filter (optional). This series of products can comply with IEC 61800-3 class C2 by installing external filter (optional).
Ambient temperature	-10 to 50°C, derate 1% for every increased 1°C when the temperature is higher than 40°C
Altitude	Below 1000m. If the elevation is above 1000m, derate 1% for every additional 100m.
Ingress protection (IP) rating	IP20 Note: The VFD with plastic casing should be installed in metal distribution cabinet which conforms to IP20 and the top of which conforms to IP3X.
Pollution level	Level 2
Safety regulation	Comply with CE requirements
Cooling mode	Forced air cooling

2.5 Product nameplate

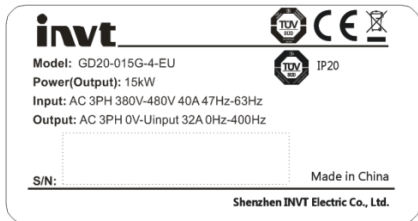
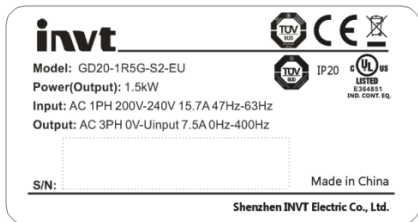

Figure 2-1 Product nameplate

Note: These are product nameplate examples for the standard products. The mark such as CE/TUV/IP20/UL will be applied according to the actual condition. The 1PH/3PH 220V models of 2.2kW and lower and the 3PH 380V models of 11kW and lower have been UL certified.

2.6 Model code

The model code contains information on the VFD. Users can find the model code on the nameplate attached to the VFD or the simple nameplate.

GD20 - 2R2G - 4 - B - EU

① ② ③ ④ ⑤

Figure 2-2 Product model

Key	No.	Detailed description	Detailed content
Abbreviation of product series	①	Abbreviation of product series	GD20: Goodrive20 series VFD
Rated power	②	Power range + load type	055: 55kW; G: Constant torque load
Voltage class	③	Voltage class	S2: 1PH 200V–240V 2: 3PH 200V - 240V 4. 3PH 380V - 480V
Additional remark 1	④	Built-in braking unit	Null: Built-in braking unit is included in standard configuration for models ≤ 37kW
			-B Built-in braking unit is optional for models ≥ 45kW, -B is its built-in braking unit model
Additional remark 2	⑤		EU: Built-in safe torque off function

2.7 Rated specifications

Model	Voltage degree	Rated output power (kW)	Rated input current (A)	Rated output current (A)	STO function
GD20-0R4G-S2-EU	Single phase 230V	0.4	6.5	2.5	Class SIL2 PLd CAT.3
GD20-0R7G-S2-EU		0.75	9.3	4.2	
GD20-1R5G-S2-EU		1.5	15.7	7.5	
GD20-2R2G-S2-EU		2.2	20	10	
GD20-0R4G-2-EU	Three phase 230V	0.4	3.7	2.5	Class SIL3 PLe CAT.3
GD20-0R7G-2-EU		0.75	5	4.2	
GD20-1R5G-2-EU		1.5	7.7	7.5	
GD20-2R2G-2-EU		2.2	11	10	
GD20-004G-2-EU		4	17	16	

Model	Voltage degree	Rated output power (kW)	Rated input current (A)	Rated output current (A)	STO function
GD20-5R5G-2-EU		5.5	21	20	
GD20-7R5G-2-EU		7.5	31	30	
GD20-0R7G-4-EU	Three phase 400V	0.75	3.4	2.5	Class SIL2 PLd CAT.3
GD20-1R5G-4-EU		1.5	5.0	4.2	
GD20-2R2G-4-EU		2.2	5.8	5.5	
GD20-004G-4-EU		4	13.5	9.5	Class SIL3 PLe CAT.3
GD20-5R5G-4-EU		5.5	19.5	14	
GD20-7R5G-4-EU		7.5	25	18.5	
GD20-011G-4-EU		11	32	25	
GD20-015G-4-EU		15	40	32	
GD20-018G-4-EU		18.5	47	38	
GD20-022G-4-EU		22	51	45	
GD20-030G-4-EU		30	70	60	
GD20-037G-4-EU		37	80	75	
GD20-045G-4-EU		45	98	92	
GD20-045G-4-B-EU		45	98	92	
GD20-055G-4-EU		55	128	115	
GD20-055G-4-B-EU		55	128	115	
GD20-075G-4-EU		75	139	150	
GD20-075G-4-B-EU		75	139	150	
GD20-090G-4-EU		90	168	180	
GD20-090G-4-B-EU	90	168	180		
GD20-110G-4-EU	110	201	215		
GD20-110G-4-B-EU	110	201	215		

2.8 Structure diagram

The following figure shows the structure of the VFD (3PH 400V, $\leq 2.2\text{kW}$) (using the 0.75kW VFD model as the example).

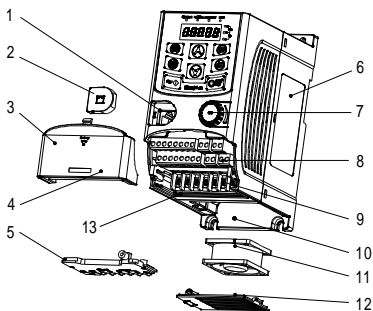

Figure 2-3 Product structure (3PH 400V, $\leq 2.2\text{kW}$)

No.	Name	Description
1	External keypad port	Connect the external keypad
2	Port cover	Protect the external keypad port
3	Cover	Protect the internal parts and components
4	Hole for the sliding cover	Fix the sliding cover
5	Trunking board	Protect the inner components and fix the cables of the main circuit
6	Name plate	See section 2.5 "Product nameplate" for details.
7	Potentiometer knob	Refer to Chapter 4 "Keypad operation".
8	Control terminals	See Chapter 3 "Installation guidelines" for details.
9	Main circuit terminals	See Chapter 3 "Installation guidelines" for details.
10	Screw hole	Fix the fan cover and fan.
11	Cooling fan	See Chapter 6 "Fault tracking" for details.
12	Fan cover	Protect the fan
13	Bar code	The same as the bar code on the name plate Note: The bar code is on the middle shell which is under the cover.

Note: In above figure, the screws at 4 and 10 are provided with packaging and specific installation depends on the requirements of customers.

The following figure shows the structure of the VFD (3PH 400V, $\geq 4\text{kW}$) (using the 4kW VFD model as the example).

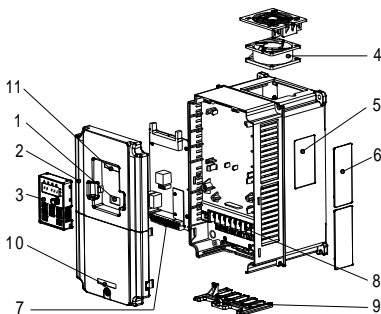



Figure 2-4 Product structure (Three phase 400V, $\geq 4\text{kW}$)

No.	Name	Description
1	External keypad port	Connect the external keypad
2	Cover	Protect the internal parts and components
3	Keypad	Refer to Chapter 4 "Keypad operation"
4	Cooling fan	See Chapter 6 "Fault tracking" for details.
5	Name plate	See section 2.5 "Product nameplate" for details.
6	Cover for the heat emission hole	Optional, enhancement of the protective degree. It is necessary to derate the VFD because the internal temperature is increasing
7	Control terminals	See Chapter 3 "Installation guidelines" for details.
8	Main circuit terminals	See Chapter 3 "Installation guidelines" for details.
9	The cable entry of the main circuit	Fix the cables
10	Simple name plate	Refer to section 2.6 "Model code".
11	Bar code	The same as the bar code on the name plate Note: The bar code is on the middle shell which is under the cover.

Chapter 3 Installation guidelines

The chapter describes the mechanical installation and electric installation of the VFD.

	<ul style="list-style-type: none"> ✧ Only qualified electricians are allowed to carry out what described in this chapter. Please operate as the instructions in Chapter 1 "Safety precautions". Ignoring these may cause physical injury or death or damage to the devices. ✧ Ensure the power supply of the VFD is disconnected during the operation. Wait for at least the time designated after the disconnection if the power supply is applied. ✧ The installation and design of the VFD should be complied with the requirement of the local laws and regulations in the installation site. If the installation infringes the requirement, our company will exempt from any responsibility. Additionally, if users do not comply with the suggestion, some damage beyond the assured maintenance range may occur.
--	--

3.1 Mechanical installation

3.1.1 Installation environment

The installation environment is the safeguard for a full performance and long-term stable functions of the VFD. Check the installation environment as follows:

Environment	Conditions
Installation site	Indoor
Environment temperature	<ul style="list-style-type: none"> ✧ -10°C to +50°C, and the temperature changing rate is less than 0.5°C/minute. ✧ If the ambient temperature of the VFD is above 40°C, derate 1% for every additional 1°C. ✧ It is not recommended to use the VFD if the ambient temperature is above 50°C. ✧ In order to improve the reliability of the device, do not use the VFD if the ambient temperature changes frequently. ✧ Please provide cooling fan or air conditioner to control the internal ambient temperature below the required one if the VFD is used in a closed space such as in the control cabinet. ✧ When the temperature is too low, if the VFD needs to restart to run after a long stop, it is necessary to provide an external heating device to increase the internal temperature; otherwise, damage to the devices may occur.
Humidity	<ul style="list-style-type: none"> ✧ RH ≤ 90%. ✧ No condensation is allowed.

Environment	Conditions
Storage temperature	-40°C to +70°C, and the temperature changing rate is less than 1°C/minute.
Running environment condition	<p>The installation site of the VFD should fulfill the following requirements.</p> <ul style="list-style-type: none"> ✧ Away from electromagnetic radiation sources. ✧ Away from oil mist, corrosive gases and combustible gases. ✧ Ensure foreign object like metal powder, dust, oil and water will not fall into the VFD (do not install the VFD onto combustible object like wood). ✧ Away from radioactive substance and combustible objects. ✧ Away from harmful gases and liquids. ✧ Low salt content. ✧ No direct sunlight.
Altitude	<ul style="list-style-type: none"> ✧ Below 1000m. ✧ When the altitude exceeds 3000m, consult the local INVT dealer or office for details. ✧ When the altitude exceeds 1000m, derate by 1% for every increase of 100m.
Vibration	Max. vibration acceleration: 5.8m/s ² (0.6g)
Installation direction	The VFD should be installed on an upright position to ensure sufficient cooling effect.

Note:

- ✧ Goodrive20-EU series VFDs should be installed in a clean and ventilated environment according to enclosure classification.
- ✧ Cooling air must be clean, free from corrosive materials and electrically conductive dust.

3.1.2 Installation direction

The VFD may be installed in a cabinet.

The VFD needs be installed in the vertical position. Check the installation site according to the requirements below. Refer to Appendix B "Dimension drawings" for details.

3.1.3 Installation mode

a) Wall and rail mounting for the VFDs (single phase 230V/three phase 400V, ≤2.2KW and three phase 230V, ≤0.75KW)

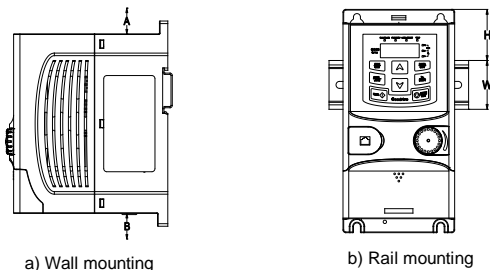

Figure 3-1 Installation

Note: the minimum space of A and B is 100mm if H is 36.6mm and W is 35.0mm.

b) Wall and flange mounting for the VFDs (three phase 400V, $\geq 4\text{KW}$ and three phase 230V, $\geq 1.5\text{KW}$)

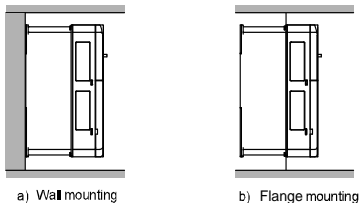

Figure 3-2 Installation

- (1) Locate the position of the installation hole.
- (2) Fix the screw or nut on the located position.
- (3) Put the VFD against the wall.
- (4) Tighten up the screws.

3.2 Standard wiring

3.2.1 Wiring of main circuit

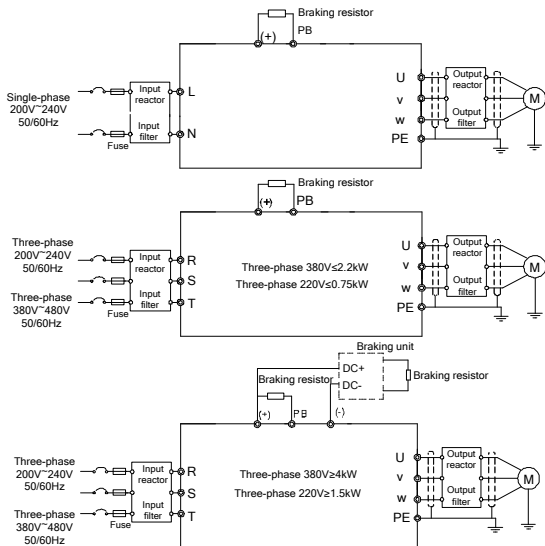

Figure 3-3 Wiring of main circuit

Note:

- ◇ The fuse, braking resistor, input reactor, input filter, output reactor, output filter are optional parts. Please refer to Appendix C "Optional peripheral accessories" for detailed information.
- ◇ Remove the yellow warning labels of PB, (+) and (-) on the terminals before connecting the braking resistor; otherwise, poor connection may occur.

3.2.2 Main circuit terminals



Figure 3-4 1PH terminals of main circuit (single phase)

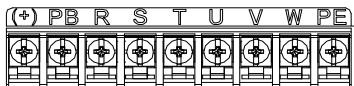

Figure 3-5 3PH terminals of main circuit (230V, $\leq 0.75\text{kW}$, and 400V, $\leq 2.2\text{kW}$)



Figure 3-6 3PH terminals of main circuit (230V, $\leq 1.5\text{kW}$, and 400V, 4-22kW)



Figure 3-7 3PH terminals of main circuit (30-37kW)

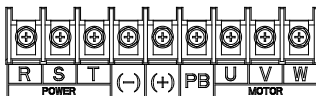

Figure 3-8 3PH terminals of main circuit (45-110kW)

Terminal	Function
L, N	Single phase AC input terminals, connected to the power supply.
R, S, T	Three phase AC input terminals, connected to the power supply.
PB, (+)	External dynamic braking resistor terminal
(+), (-)	Input terminal of the DBU or DC bus
U, V, W	Three phase AC output terminals which are generally connected to motor.
PE	Protective grounding terminal

Note:

- ◇ Do not use asymmetrically motor cables. If there is a symmetrically grounding conductor in the motor cable in addition to the conductive shield, connect the grounding conductor to the grounding terminal at the VFD and motor ends.
- ◇ Route the motor cable, input power cable and control cables separately.

3.2.3 Wiring of main circuit terminals

1. Connect the ground wire of the input power cable to the ground terminal (PE) of the VFD, and connect the 3PH input cable to the terminals R, S, and T, and fasten them up.
2. Connect the ground wire of the motor cable to the ground terminal of the VFD, and connect the 3PH motor cable to the terminals U, V, and W, and fasten them up.
3. Connect the braking resistor and other accessories that are equipped with cables to the specified positions.
4. Fasten all the cables outside of the VFD mechanically, if possible.

3.2.4 Wiring of control circuit

Figure 3-9 Wiring of control circuit for VFDs ≤ 2.2 kW (1PH 230V, 3PH 400V) & ≤ 0.75 kW (3PH 230V)

Figure 3-10 Wiring of control circuit for VFDs $\geq 1.5\text{kW}$ (3PH 230V) & $\geq 4\text{kW}$ (3PH 400V)

3.2.5 Control circuit terminals

Figure 3-11 Connection terminal diagram for VFDs $\leq 2.2\text{ kW}$ (1PH 230V, 3PH 400V) & $\leq 0.75\text{kW}$ (3PH 230V)Figure 3-12 Connection terminal diagram for VFDs $\geq 1.5\text{kW}$ (3PH 230V) & $\geq 4\text{kW}$ (3PH 400V)

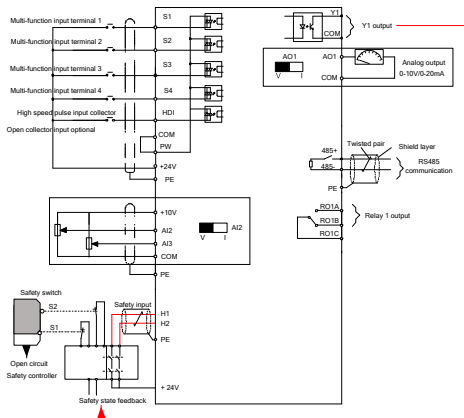
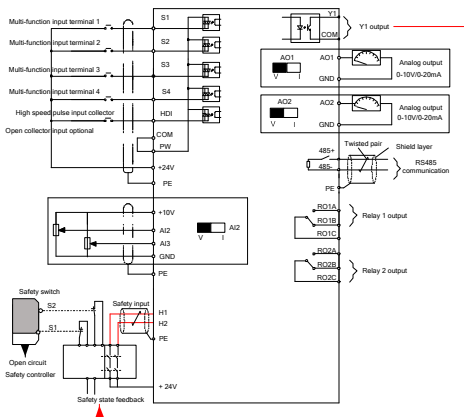
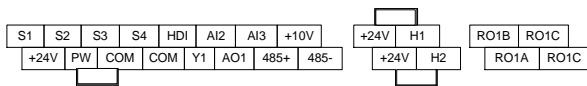
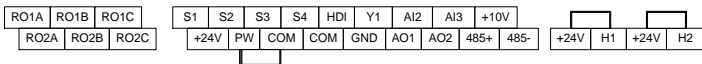
Type	Terminal name	Function description	Technical specifications
Communication	485+ 485-	485 communication	485 communication interface
Digital input/output	S1	Digital input	1. Internal impedance: 3.3kΩ 2. 12–30V voltage input is available 3. The terminal is the dual-direction input
	S2		
	S3		
	S4		

Type	Terminal name	Function description	Technical specifications
			terminal 4. Max. input frequency: 1kHz
	HDI	High frequency input channel	Except for S1–S4, this terminal can be used as high frequency input channel. Max. input frequency: 50kHz Duty cycle: 30%–70%
	PW	Digital power supply	External power input terminal for digital input circuits Power range: 12 V–30 V
	Y1	Digital output	1. Contact capacity: 50mA/30V; 2. Output frequency range: 0–1kHz; 3. Default is STO state output indicator.
STO function input	24V-H1	STO input 1	1. Safe torque stop (STO) redundant input, externally connected to NC contact, STO acts when the contact is open, and the drive stops output; 2. The safe input signal cable should be shield cable within 25m.
	24V-H2	STO input 2	3. When employing STO function, please disassemble the short circuit plate on the terminals shown in Figure 3-11 and Figure 3-12.
24V power supply	+24V	24V power supply	External 24V±10% power supply and the maximum output current is 200mA. Generally used as the operation power supply of digital input and output or external sensor power supply
	COM		
Analog input/output	+10V	External 10V reference power supply	10V reference power supply Max. output current: 50mA As the adjusting power supply of the external potentiometer Potentiometer resistance: 5kΩ above
	AI2	Analog input	1. Input range: AI2 voltage and current can be chosen: 0–10V/0–20mA; AI3: -10V–+10V. 2. Input impedance: voltage input: 20kΩ;
	AI3		

Type	Terminal name	Function description	Technical specifications
			current input: 500Ω. 3. Voltage or current input can be set by dip switch. 4. Resolution: The minimum AI2/AI3 is 10mV/20mV when 10V corresponds to 50Hz.
	AO1	Analog output	1. Output range: 0–10V voltage or 0–20mA current; 2. Voltage or current output is set by jumpers or toggle switch; 3. Error $\pm 1\%$, 25°C; 4. There is only one AO1 for VFDs $\leq 2.2\text{kW}$.
	AO2		
Relay output	RO1A	Relay 1 NO contact	1. Contact capacity: 3A/AC250V, 1A/DC30V; 2. Please note that it should not be used as high frequency switch output; 3. There is only one relay output for VFDs $\leq 2.2\text{kW}$.
	RO1B	Relay 1 NC contact	
	RO1C	Relay 1 common contact	
	RO2A	Relay 2 NO contact	
	RO2B	Relay 2 NC contact	
	RO2C	Relay 2 common contact	

3.2.6 Input/output signal connection figure

Use U-shaped jumper to set NPN mode or PNP mode and the internal or external power supply. The default setting is the PNP internal mode.

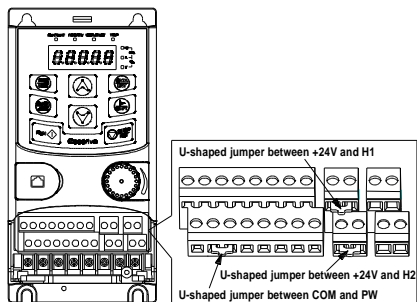

Figure 3-13 U-shaped jumper

If the signal is from NPN transistor, set the U-shaped jumper between +24V and PW as below according to the used power supply.

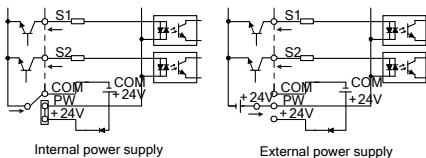

Figure 3-14 NPN mode

If the signal is from PNP transistor, set the U-shaped jumper as below according to the used power supply.

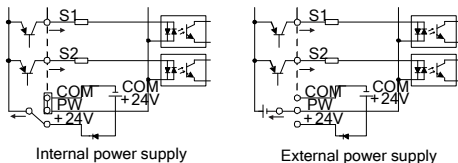

Figure 3-15 PNP modes

3.3 Overview of STO function

Reference standards: IEC 61508-1, IEC 61508-2, IEC 61508-3, IEC 61508-4, IEC 62061, ISO 13849-1, IEC 61800-5-2.

The STO function can be used where main power of the drive is on to prevent unexpected start. The function cuts off the drive signal to disable the drive output, thus preventing motor from unexpected start (refer to below figure). After enabling STO function, short-time operations (like non-electrical cleaning-up in lathe industry) and/or maintenance on non-electrical parts can be conducted.

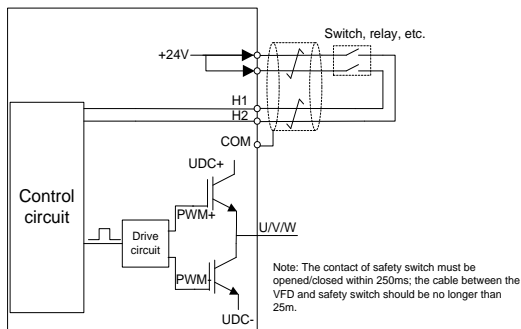

Figure 3-16 STO function schematic

3.3.1 Logic table for STO function

Input states and corresponding faults of STO function:

STO input state	Corresponding STO fault
H1, H2 opens simultaneously	Trigger STO function, the drive can't operate normally
H1, H2 closes simultaneously	Don't trigger STO function, the drive can operate normally
Either H1 or H2 opens or closes	Trigger STL1/STL2/STL3 fault, fault code: 38: Safety circuit of channel 1 is abnormal (STL1) 39: Safety circuit of channel 2 is abnormal (STL2) 40: Internal circuit is abnormal (STL3)

3.3.2 Description of STO channel delay

STO channel trigger and indication delay time:

STO mode	STO trigger delay ¹ and STO indication delay ²
STO fault: STL1	Trigger delay < 10ms Indication delay < 280ms
STO fault: STL2	Trigger delay < 10ms Indication delay < 280ms
STO fault: STL3	Trigger delay < 10ms Indication delay < 280ms
STO fault: STO	Trigger delay < 10ms Indication delay < 100ms

1: STO trigger delay: Time interval between trigger the STO function and switching off the drive output.

2: STO indication delay: Time interval between trigger the STO function and STO output state indication.

3.3.3 STO function installation checklist

Before installing STO, please perform self-inspection according to below table to ensure the effectiveness of STO.

	Item
<input type="checkbox"/>	Ensure that the drive can be run and stopped freely during commissioning.
<input type="checkbox"/>	Stop the drive (if running), cut off input power and isolate the drive from the power cable via the switch
<input type="checkbox"/>	Check STO circuit connection against circuit diagram.
<input type="checkbox"/>	Check that the shield of STO input cable is connected to +24V reference GND COM
<input type="checkbox"/>	Power on
<input type="checkbox"/>	Test the operation of STO when the motor is stopped: <ul style="list-style-type: none"> • Give a stop command to the drive (if running) and wait until the motor shaft is at standstill. • Activate STO function and give a start command to the drive, ensure the motor stays at standstill. • Inactivate STO circuit.
<input type="checkbox"/>	Restart the drive and check if the motor runs normally
<input type="checkbox"/>	Test the operation of STO function when the motor is running: <ul style="list-style-type: none"> • Start the drive and ensure the motor runs normally. • Activate STO circuit. • The drive reports STO fault (refer to fault and countermeasure in page X), ensure that motor coast to stop and stops rotation. • Inactivate STO circuit.
<input type="checkbox"/>	Restart the drive and check if the motor runs normally

3.4 Layout protection

3.4.1 Protecting the VFD and input power cable in short-circuit situations

Protect the VFD and input power cable in short circuit situations and against thermal overload.

Arrange the protection according to the following guidelines.

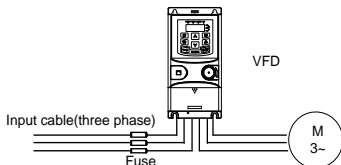

Figure 3-17 Fuse configuration

Note: Select the fuse as the manual indicated. The fuse will protect the input power cable from damage in short-circuit situations. It will protect the surrounding devices when the internal of the VFD is short circuited.

3.4.2 Protect the motor and motor cables

The VFD protects the motor and motor cable in a short-circuit situation when the motor cable is dimensioned according to the rated current of the VFD. No additional protection devices are needed.



- ◇ If the VFD is connected to multiple motors, a separate thermal overload switch or a circuit breaker must be used for protecting each cable and motor. These devices may require a separate fuse to cut off the short-circuit current.

3.4.3 Implementing a bypass connection

It is necessary to set power frequency and variable frequency conversion circuits for the assurance of continuous normal work of the VFD if faults occur in some significant situations.

In some special situations, for example, if it is only used in soft start, the VFD can be converted into power frequency running after starting and some corresponding bypass should be added.



- ◇ Never connect the supply power to the VFD output terminals U, V and W. Power line voltage applied to the output can result in permanent damage to the VFD.

If frequent shifting is required, employ mechanically connected switches or contactors to ensure that the motor terminals are not connected to the AC power line and VFD output terminals simultaneously.

Chapter 4 Keypad operation

4.1 Keypad introduction

You can use the keypad to control the start and stop, read status data, and set parameters of the VFD.

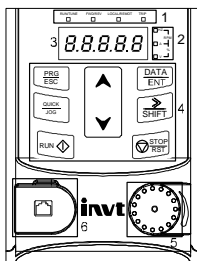

Figure 4-1 Film-type keypad

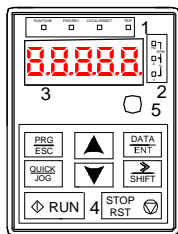
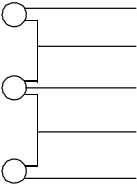



















Figure 4-2 External keypad

Note:

- ◇ A film-type keypad is a standard configuration for the VFD models of 1PH 230V/3PH 400V ($\leq 2.2\text{kW}$) and 3PH ($\leq 0.75\text{kW}$). An external keypad is a standard configuration for the VFD models of 3PH 400V ($\geq 4\text{kW}$) and 3PH 230V ($\geq 1.5\text{kW}$).
- ◇ In addition, if you need, an external keypad (an optional part) can be provided (including the external keypads with and without the function of parameter copying).

No.	Name	Description					
1	State LED	RUN/TUNE	LED off—the VFD is stopped LED blinking—the VFD is in parameter autotune LED on—the VFD is running				
		FWD/REV	LED off—the VFD will run in the forward direction; LED on—the VFD will run in the reverse direction				
		LOCAL/REMOT	LED indicates keypad operation, terminal operation and remote communication control LED off—the VFD is in keypad operation mode LED blinking—the VFD is in terminal operation mode LED on—the VFD is in remote operation control mode				
		TRIP	LED for faults LED on—the VFD is faulty LED off—normal state LED blinking—the VFD is in pre-alarm, and will trip soon without corrective actions				
2	Unit LED	Mean the unit displayed currently					
			Hz	Frequency unit			
			RPM	Rotating speed unit			
			A	Current unit			
			%	Percentage			
	V	Voltage unit					
3	Digital display zone	5-figure LED display displays various monitoring data and alarm code such as set frequency and output frequency.					
		Display	Means	Display	Means	Display	Means
		0	0	1	1	2	2
		3	3	4	4	5	5
		6	6	7	7	8	8
		9	9	A.	A	b.	B
		C.	C	d	d	E.	E
		F.	F	H.	H	l.	l
L.	L	n.	N	n	n		

No.	Name	Description					
			o		P		r
			S		t		U
			v		.		-
4	Buttons		Programming key	Enter or escape from the first level menu and remove the parameter quickly			
			Entry key	Enter the menu step-by-step Confirm parameters			
			UP key	Increase data or function code progressively			
			DOWN key	Decrease data or function code progressively			
			Right-shift key	Move right to select the displaying parameter circularly in stopping and running mode. Select the parameter modifying digit during the parameter modification			
			Run key	This key is used to operate on the VFD in key operation mode			
			Stop/Reset key	This key is used to stop in running state and it is limited by function code P07.04. This key is used to reset all control modes in the fault alarm state			
			Quick key	The function of this key is confirmed by function code P07.02.			
5	Analog potential meter	<p>AI1, When the external common keypad (without the function of parameter copy) is valid, the difference between the local keypad AI1 and the external keypad AI1 is:</p> <p>When the external keypad AI1 is set to the Min. value, the local keypad AI1 will be valid and P17.19 will be the voltage of the local keypad AI1; otherwise, the external keypad AI1 will be valid and P17.19 will be the voltage of the external keypad AI1.</p> <p>Note: If the external keypad AI1 is frequency reference source, adjust the local potentiometer AI1 to 0V/0mA before starting the VFD.</p>					
6	Keypad port	External keypad port. When the external keypad with the function of parameter copying is valid, the local keypad LED is off; When the external keypad without the function of parameter copying is valid, the local and					

No.	Name	Description
		external keypad LEDs are on. Note: Only the external keypad which has the function of parameters copy owns the function of parameters copy, other keypads do not have. (only for the VFDs≤2.2kW)

4.2 Keypad display

The keypad of Goodrive20-EU series VFD displays the stopped-state parameters, running-state parameters, function parameter editing status, and fault alarm status.

4.2.1 Displaying stopped-state parameters

When the VFD is in stopped state, the keypad displays stopped-state parameters.

In the stopped state, parameters in various states can be displayed. You can determine which parameters are displayed by setting the binary bits of P07.07. For definitions of the bits, see the description of P07.07.

In stopping state, there are 14 parameters that can be selected for display, including set frequency, bus voltage, input terminal status, output terminal status, PID reference value, PID feedback value, torque setting, AI1, AI2, AI3, high-speed pulse HDI frequency, PLC and the current step of multi-step speed, pulse counting value, length value. P07.07 can select the parameter to be displayed or not by bit, and you can press **»/SHIFT** to shift selected parameters from left to right or press **QUICK/JOG** to shift selected parameters from right to left.

4.2.2 Displaying running-state parameters

After receiving a valid running command, the VFD enters the running state, and the keypad displays running-state parameters, with the **RUN/TUNE** indicator on. The on/off state of the **FWD/REV** indicator is determined by the current running direction.

In running state, there are 24 parameters that can be selected for display, including running frequency, set frequency, bus voltage, output voltage, output current, running speed, output power, output torque, PID reference value, PID feedback value, input terminal status, output terminal status, torque setting, length value, PLC and the current step of multi-step speed, AI1, AI2, AI3, high-speed pulse HDI frequency, motor overload percentage, VFD overload percentage, ramp reference value, linear speed, and AC input current. P07.05 and P07.06 can select the parameter to be displayed or not by bit, and you can press **»/SHIFT** to shift selected parameters from left to right or press **QUICK/JOG** to shift selected parameters from right to left.

4.2.3 Displaying fault information

After detecting a fault signal, the VFD enters the fault alarm state immediately, the fault code blinks on the keypad, and the **TRIP** indicator is on. You can perform fault reset by using the

STOP/RST key, control terminals, or communication commands.

If the fault persists, the fault code is continuously displayed.

4.2.4 Editing function codes

You can press the **PRG/ESC** key to enter the editing mode in stopped, running, or fault alarm state (if a user password is used, see the description of P07.00). The editing mode contains two levels of menus in the following sequence: Function code group or function code number → Function code setting. You can press the **DATA/ENT** key to enter the function parameter display interface. On the function parameter display interface, you can press the **DATA/ENT** key to save parameter settings or press the **PRG/ESC** key to exit the parameter display interface.



Figure 4-3 Status display

4.3 Operations on the keypad

You can operate the VFD by using the keypad. For details about function code descriptions, see the function code list.

4.3.1 Modifying VFD function codes

The VFD provides three levels of menus, including:

1. Function code group number (level-1 menu)
2. Function code number (level-2 menu)
3. Function code setting (level-3 menu)

Note: When performing operations on the level-3 menu, you can press the **PRG/ESC** or **DATA/ENT** key to return to the level-2 menu. If you press the **DATA/ENT** key, the set value of the parameter is saved to the control board first, and then the level-2 menu is returned, displaying the next function code. If you press the **PRG/ESC** key, the level-2 menu is returned directly, without saving the set value of the parameter, and the current function code is displayed.

If you enter the level-3 menu but the parameter does not have a digit blinking, the parameter cannot be modified due to either of the following reasons:

- 1) It is read only. Read-only parameters include actual detection parameters and running record parameters.

2) It cannot be modified in running state and can be modified only in stopped state.

Example: Change the value of P00.01 from 0 to 1.

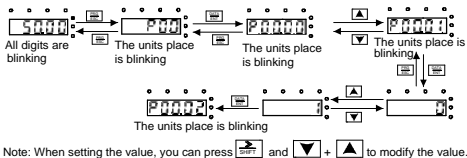

Figure 4-4 Modifying a parameter

4.3.2 Setting a password for the VFD

Goodrive20-EU series VFDs provide password protection function to users. Set P07.00 to gain the password and the password protection becomes effective 1 minute later after retreating from the function code editing state. Press **PRG/ESC** again to the function code editing state, "0.0.0.0.0" will be displayed. Unless using the correct password, you cannot enter it.

To disable the password protection function, you need only to set P07.00 to 0.

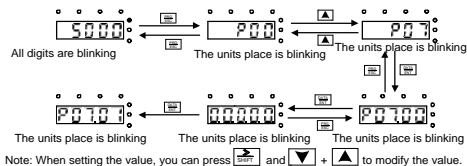

Figure 4-5 Setting a password

4.3.3 Viewing VFD status

The VFD provides group P17 for status viewing. You can enter group P17 for viewing.

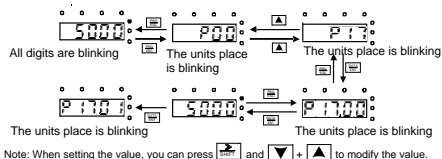

Figure 4-6 Viewing a parameter

Chapter 5 Function parameters

The function parameters of Goodrive20-EU series VFDs have been divided into 30 groups (P00–P29) according to the function, of which P18–P28 are reserved. Each function group contains certain function codes. A three-level menu style is applied to function codes. For example, "P08.08" indicates the 8th function code in the P8 group. The P29 group consist of factory function parameters, which are user inaccessible.

The function group numbers correspond to the level-1 menus, the function codes correspond to the level-2 menus, and the function parameters correspond to the level-3 menus.

1. The content of the function code table is as follows:

Column 1 "Function code": Code of the function group and parameter.

Column 2 "Name": Full name of the function parameter.

Column 3 "Description": Detailed description of the function parameter.

Column 4 "Default": Initial value set in factory.

Column 5 "Modify": Whether the function parameter can be modified, and conditions for the modification.

"○" indicates that the value of the parameter can be modified when the VFD is in the stop or running state.

"◎" indicates that the value of the parameter cannot be modified when the VFD is in the running state.

"●" indicates that the value of the parameter is detected and recorded, and cannot be modified.

P00 group Basic functions

Function code	Name	Description	Default	Modify
P00.00	Speed control mode	0: SVC 0 No need to install encoders. Suitable in applications which need low frequency, big torque for high accuracy of rotating speed and torque control. Relative to mode 1, it is more suitable for the applications which need small power. 1: SVC 1 1 is suitable in high performance cases with the advantage of high accuracy of rotating speed	2	◎

Function code	Name	Description	Default	Modify
		and torque. It does not need to install pulse encoder. 2: SVPWM control Suitable in applications which do not need high control accuracy, such as the load of fan and pump. One VFD can drive multiple motors. Note: Motor parameter autotuning is required when vector mode is applied.		
P00.01	Run command channel	Select the run command channel of the VFD. The control command of the VFD includes: start, stop, forward/reverse rotating, jogging and fault reset. 0: Keypad ("LOCAL/REMOT" light off) Carry out the command control by RUN , STOP/RST on the keypad. Set the multi-function key QUICK/JOG to FWD/REVC shifting function (P07.02=3) to change the running direction; press RUN and STOP/RST simultaneously in running state to make the VFD coast to stop. 1: Terminal ("LOCAL/REMOT" flickering) Carry out the running command control by the forward rotation, reverse rotation and forward jogging and reverse jogging of the multi-function terminals 2:Communication ("LOCAL/REMOT" on); The running command is controlled by the upper monitor via communication	0	○
P00.03	Max. output frequency	The parameter is used to set the max. output frequency of the VFD. It is the basis of frequency setup and the acceleration/deceleration. Setting range: P00.04–400.00Hz	50.00Hz	◎
P00.04	Upper limit of running frequency	The upper limit of the running frequency is the upper limit of the output frequency of the VFD which is lower than or equal to the maximum frequency. Setting range: P00.05–P00.03 (max. output frequency)	50.00Hz	◎

Function code	Name	Description	Default	Modify
P00.05	Lower limit of running frequency	The lower limit of the running frequency is that of the output frequency of the VFD. The VFD runs at the lower limit frequency if the set frequency is lower than the lower limit. Note: Max. output frequency \geq upper limit frequency \geq lower limit frequency Setting range: 0.00Hz–P00.04 (upper limit of the running frequency)	0.00Hz	☉
P00.06	A frequency command selection	Note: A frequency and B frequency cannot set as the same frequency reference method. The frequency source can be set by P00.09. 0: Set via keypad digits	0	○
P00.07	B frequency command selection	Modify the value of function code P00.10 (set the frequency by keypad) to change the frequency by the keypad. 1: Set via AI1 (corresponding keypad potentiometer) 2: Set via AI2 (corresponding terminal AI2) 3: Set via AI3 (corresponding terminal AI3) Set the frequency by analog input terminals. Goodrive20-EU series VFDs provide 3 channels analog input terminals as the standard configuration, of which AI1 is adjusting through analog potentiometer, while AI2 is the voltage/current option (0–10V/0–20mA) which can be shifted by jumpers; while AI3 is voltage input (-10V→+10V). Note: When analog AI2 select 0–20mA input, the corresponding voltage of 20mA is 10V. 100.0% of the analog input setting corresponds to the maximum frequency (function code P00.03) in forward direction and -100.0% corresponds to the maximum frequency in reverse direction (function code P00.03) 4: Set via high-speed pulse HDI The frequency is set by high-speed pulse terminals. Goodrive20 series VFDs provide 1 high speed pulse input as the standard configuration. The pulse frequency range is 0.000–50.000kHz.	2	○

Function code	Name	Description	Default	Modify
		<p>100.0% of the high speed pulse input setting corresponds to the maximum frequency in forward direction (function code P00.03) and -100.0% corresponds to the maximum frequency in reverse direction (function code P00.03).</p> <p>Note: The pulse setting can only be input by multi-function terminals HDI. Set P05.00 (HDI input selection) to high speed pulse input.</p> <p>5: Set via simple PLC program The VFD runs at simple PLC program mode when P00.06=5 or P00.07=5. Set P10 (simple PLC and multi-step speed control) to select the running frequency running direction, ACC/DEC time and the keeping time of corresponding stage. See the function description of P10 for detailed information.</p> <p>6: Set via multi-step speed running The VFD runs at multi-step speed mode when P00.06=6 or P00.07=6. Set P05 to select the current running step, and set P10 to select the current running frequency. The multi-step speed has the priority when P00.06 or P00.07 does not equal to 6, but the setting stage can only be the 1–15 stage. The setting stage is 1–15 if P00.06 or P00.07 equals to 6.</p> <p>7: Set via PID control The running mode of the VFD is process PID control when P00.06=7 or P00.07=7. It is necessary to set P09. The running frequency of the VFD is the value after PID effect. See P09 for the detailed information of the preset source, preset value and feedback source of PID.</p> <p>8: Set via Modbus communication The frequency is set by Modbus communication. See P14 for detailed information.</p> <p>9–11: Reserved</p>		

Function code	Name	Description	Default	Modify
P00.08	B frequency command reference selection	0: Maximum output frequency, 100% of B frequency setting corresponds to the maximum output frequency 1: A frequency command, 100% of B frequency setting corresponds to the maximum output frequency. Select this setting if it needs to adjust on the base of A frequency command.	0	<input type="radio"/>
P00.09	Combination of the setting source	0: A, the current frequency setting is A frequency command 1: B, the current frequency setting is B frequency command 2: A+B, the current frequency setting is A frequency command + B frequency command 3: A-B, the current frequency setting is A frequency command - B frequency command 4: Max. (A, B): The bigger one between A frequency command and B frequency is the set frequency. 5: Min. (A, B): The lower one between A frequency command and B frequency is the set frequency. Note: The combination manner can be shifted by P05 (terminal function)	0	<input type="radio"/>
P00.10	Keypad set frequency	When A and B frequency commands are selected as "keypad setting", this parameter will be the initial value of VFD reference frequency Setting range: 0.00 Hz –P00.03 (the max. frequency)	50.00Hz	<input type="radio"/>
P00.11	Acceleration time 1	Acceleration time means the time needed for the VFD to speed up from 0Hz to the maximum output frequency (P00.03).	Depend on model	<input type="radio"/>
P00.12	Deceleration time 1	Deceleration time means the time needed if the VFD speeds down from the maximum output frequency (P00.03) to 0Hz. Goodrive20-EU series VFDs have four groups of ACC/DEC time which can be selected by P05. The default ACC/DEC time of the VFD is the first group.	Depend on model	<input type="radio"/>

Function code	Name	Description	Default	Modify																								
		Setting range of P00.11 and P00.12: 0.0–3600.0s																										
P00.13	Running direction selection	<p>0: Runs at the default direction, the VFD runs in the forward direction. FWD/REV indicator is off.</p> <p>1: Runs at the opposite direction, the VFD runs in the reverse direction. FWD/REV indicator is on. Modify the function code to shift the rotation direction of the motor. This effect equals to the shifting the rotation direction by adjusting either two of the motor lines (U, V and W). The motor rotation direction can be changed by QUICK/JOG on the keypad. Refer to parameter P07.02.</p> <p>Note: When the function parameter comes back to the default value, the motor's running direction will come back to the factory default state, too. In some cases it should be used with caution after commissioning if the change of rotation direction is disabled.</p> <p>2: Forbid to run in reverse direction: It can be used in some special cases if the reverse running is disabled.</p>	0	<input type="radio"/>																								
P00.14	Carrier frequency setting	<table border="1" style="margin-left: auto; margin-right: auto;"> <thead> <tr> <th>Carrier frequency</th> <th>Electro magnetic noise</th> <th>Noise and leakage current</th> <th>Heating eliminating</th> </tr> </thead> <tbody> <tr> <td>1kHz</td> <td style="text-align: center;">↑ High</td> <td style="text-align: center;">↑ Low</td> <td style="text-align: center;">↑ Low</td> </tr> <tr> <td>10kHz</td> <td style="text-align: center;">↓ Low</td> <td style="text-align: center;">↓ High</td> <td style="text-align: center;">↓ High</td> </tr> <tr> <td>15kHz</td> <td style="text-align: center;">↓ Low</td> <td style="text-align: center;">↓ High</td> <td style="text-align: center;">↓ High</td> </tr> </tbody> </table> <p>Relationship between motor types and carrier frequencies:</p> <table border="1" style="margin-left: auto; margin-right: auto;"> <thead> <tr> <th>Motor type</th> <th>Factory setting of carrier frequency</th> </tr> </thead> <tbody> <tr> <td>0.4–11kW</td> <td>8kHz</td> </tr> <tr> <td>15–55kW</td> <td>4kHz</td> </tr> <tr> <td>75–110kW</td> <td>2kHz</td> </tr> </tbody> </table> <p>The advantage of high carrier frequency: ideal current waveform, little current harmonic wave and motor noise.</p>	Carrier frequency	Electro magnetic noise	Noise and leakage current	Heating eliminating	1kHz	↑ High	↑ Low	↑ Low	10kHz	↓ Low	↓ High	↓ High	15kHz	↓ Low	↓ High	↓ High	Motor type	Factory setting of carrier frequency	0.4–11kW	8kHz	15–55kW	4kHz	75–110kW	2kHz	Depend on model	<input type="radio"/>
Carrier frequency	Electro magnetic noise	Noise and leakage current	Heating eliminating																									
1kHz	↑ High	↑ Low	↑ Low																									
10kHz	↓ Low	↓ High	↓ High																									
15kHz	↓ Low	↓ High	↓ High																									
Motor type	Factory setting of carrier frequency																											
0.4–11kW	8kHz																											
15–55kW	4kHz																											
75–110kW	2kHz																											

Function code	Name	Description	Default	Modify
		<p>The disadvantage of high carrier frequency: increasing the switch loss, increasing VFD temperature and the impact to the output capacity. The VFD needs to derate on high carrier frequency. At the same time, the leakage and electrical magnetic interference will increase.</p> <p>Applying low carrier frequency is contrary to the above, too low carrier frequency will cause unstable running, torque decreasing and surge.</p> <p>The manufacturer has set a reasonable carrier frequency when the VFD is in factory. In general, users do not need to change the parameter.</p> <p>When the frequency used exceeds the default carrier frequency, the VFD needs to derate 10% for each additional 1k carrier frequency.</p> <p>Setting range: 1.0–15.0kHz</p>		
P00.15	Motor parameter autotuning	<p>0: No operation 1: Rotary autotuning Comprehensive motor parameter autotune It is recommended to use rotating autotuning when high control accuracy is needed. 2: Static autotuning 1 (autotune totally); It is suitable in the cases when the motor cannot de-couple from the load. The autotuning for the motor parameter will impact the control accuracy. 3: Static autotuning 2 (autotune part parameters); when the current motor is motor 1, autotune P02.06, P02.07, P02.08</p>	0	☉
P00.16	AVR function selection	<p>0: Invalid 1: Valid during the whole procedure The auto-adjusting function of the VFD can cancel the impact on the output voltage of the VFD because of the bus voltage fluctuation.</p>	1	○
P00.18	Function restore parameter	<p>0–6 0: No operation 1: Restore the default value (excluding the motor parameters)</p>	0	☉

Function code	Name	Description	Default	Modify
		2: Clear fault records 3: Function code locking (lock all function codes) 4: Reserved 5: Restore the default value (factory test mode) 6: Restore the default value (including the motor parameters) Note: 1. After the selected operation is performed, the function code is automatically restored to 0. Restoring default values may delete the user password. Exercise caution when using this function. 2. Restoring default values (factory test mode) will restore the parameters to the corresponding standard version. Non-professionals shall exercise caution when using this function.		

P01 group Start and stop control

Function code	Name	Description	Default	Modify
P01.00	Start mode	0: Start-up directly: start from the starting frequency P01.01 1: Start-up after DC braking: start the motor from the starting frequency after DC braking (set the parameter P01.03 and P01.04). It is suitable in the cases where reverse rotation may occur to the low inertia load during starting. 2: Start after speed tracking 1 3: Start after speed tracking 2 The direction and speed will be tracked automatically for the smoothing starting of rotating motors. It suits the application with reverse rotation when big load starting. Note: This function is only available for the VFDs \geq 4kW.	0	☉
P01.01	Starting frequency of direct start-up	Starting frequency of direct start-up means the original frequency during the VFD starting. See P01.02 for detailed information.	0.50Hz	☉

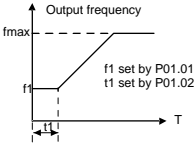
Function code	Name	Description	Default	Modify
		Setting range: 0.00–50.00Hz		
P01.02	Hold time of the starting frequency	<p>Set a proper starting frequency to increase the torque of the VFD during starting. During the retention time of the starting frequency, the output frequency of the VFD is the starting frequency. And then, the VFD will run from the starting frequency to the set frequency. If the set frequency is lower than the starting frequency, the VFD will stop running and keep in the stand-by state. The starting frequency is not limited in the lower limit frequency.</p>  <p>Setting range: 0.0–50.0s</p>	0.0s	⊙
P01.03	Braking current before starting	The VFD will carry out DC braking at the braking current set before starting and it will speed up after the DC braking time. If the DC braking time is set to 0, the DC braking is invalid.	0.0%	⊙
P01.04	Braking time before starting	<p>The stronger the braking current, the bigger the braking power. The DC braking current before starting is the percentage of rated current of the VFD.</p> <p>Setting range of P01.03: 0.0–100.0% (rated current peak of the VFD)</p> <p>Setting range of P01.04: 0.00–50.00s</p>	0.00s	⊙
P01.05	Acceleration/ deceleration selection	<p>The changing mode of the frequency during start-up and running.</p> <p>0: Linear type</p> <p>The output frequency increases or decreases linearly.</p>	0	⊙

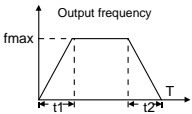
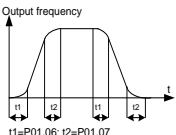
Function code	Name	Description	Default	Modify
		 <p>1: S curve The output frequency increases or decreases progressively according to the S curve. The S curve type is generally applied in elevators, conveyors, and other application scenarios where smoother start or stop is required.</p>  <p>$t1=P01.06; t2=P01.07$</p>		
P01.06	Acceleration time of the starting step of S curve	Setting rage: 0.0–50.0s Note: Effective when P01.05 is 1	0.1s	☉
P01.07	Deceleration time of the ending step of S curve		0.1s	☉
P01.08	Stop selection	0: Decelerate to stop: after the stop command becomes valid, the VFD decelerates to reduce the output frequency during the set time. When the frequency decreases to 0Hz, the VFD stops. 1: Coast to stop: after the stop command becomes valid, the VFD ceases the output immediately. And the load coasts to stop at the mechanical inertia.	0	○
P01.09	Starting frequency of DC braking while stop	Starting frequency of DC braking: start the DC braking when running frequency reaches starting frequency determined by P01.09. Waiting time before DC braking: VFDs blocks the	0.00Hz	○

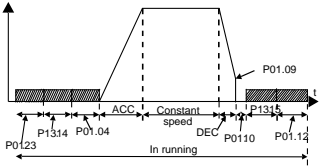
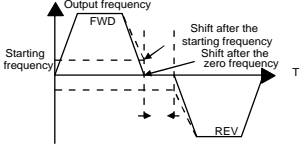
Function code	Name	Description	Default	Modify
P01.10	Stop brake waiting time	output before starting the DC braking. After this waiting time, the DC braking will be started so as to prevent over-current fault caused by DC braking at high speed.	0.00s	○
P01.11	Stop DC braking current		0.0%	○
P01.12	Stop DC braking time	<p>DC braking current: the value of P01.11 is the percentage of rated current of VFD. The bigger the DC braking current is, the greater the braking torque is.</p> <p>DC braking time: the retention time of DC braking. If the time is 0, the DC braking is invalid, and the VFD will coast to stop.</p>  <p>Setting range of P01.09: 0.00Hz –P00.03 (the max. frequency) Setting range of P01.10: 0.00–50.00s Setting range of P01.11: 0.0–100.0% (rated current peak of the VFD) Setting range of P01.12: 0.00–50.00s</p>	0.00s	○
P01.13	FWD/REV running deadzone time	<p>This function code indicates the transition time specified in P01.14 during FWD/REV rotation switching. See the following figure.</p>  <p>Setting range: 0.0–3600.0s</p>	0.0s	○
P01.14	FWD/REV switching mode	<p>Set the threshold point of the VFD: 0: Switch at zero frequency</p>	1	◎

Function code	Name	Description	Default	Modify
		1: Switch at the start frequency 2: Switch after the speed reaches the stop speed (P01.15) for the set the delay (P01.24)		
P01.15	Stop speed	0.00–100.00Hz	0.50Hz	☉
P01.16	Stop speed detection mode	0: Set value of speed (the only detection mode valid in V/F mode) 1: Detection value of speed	1	☉
P01.17	Detection time of the feedback speed	<p>When P01.16=1, the actual output frequency of the VFD is less than or equal to P01.15 and is detected during the time set by P01.17, the VFD will stop; otherwise, the VFD stops in the time set by P01.24.</p> <p>Setting range: 0.00–100.00s (valid only when P01.16=1)</p>	.50 s	☉
P01.18	Power-on terminal running protection selection	<p>When the running command channel is the terminal control, the system will detect the state of the running terminal during powering on.</p> <p>0: The terminal running command is invalid when powering on. Even the running command is detected to be valid during powering on, the VFD won't run and the system keeps in the protection state until the running command is canceled and enabled again.</p> <p>1: The terminal running command is valid when powering on. If the running command is detected to be valid during powering on, the system will start the VFD automatically after the initialization.</p> <p>Note: This function should be selected with cautions, or serious result may follow.</p>	0	○

Function code	Name	Description	Default	Modify
P01.19	Action selected when running frequency less than frequency lower limit (valid when frequency lower limit is larger than 0)	0x00–0x12 Ones place: Action selection 0: Run at the frequency lower limit 1: Stop 2: Sleep Tens place: Stop mode 0: Coast to stop 1: Decelerate to stop	0x00	☉
P01.20	Wake-up-from-sleep delay	<p>This function code determines the wake-up-from-sleep delay time. When the running frequency of the VFD is lower than the lower limit, the VFD becomes standby. When the set frequency exceeds the lower limit one again and it lasts for the time set by P01.20, the VFD runs automatically.</p> <p>Setting range: 0.0–3600.0s (valid when the ones place of P01.19=2)</p>	0.0s	○
P01.21	Restart after power off	This function can enable the VFD to start or not after power off and power on. 0: Disabled 1: Enabled, if the starting need is met, the VFD will run automatically after waiting for the time defined by P01.22.	0	○
P01.22	The waiting time of restart after power off	The function determines the waiting time before the automatic running of the VFD when powering off and powering on.	1.0s	○

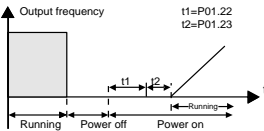
Function code	Name	Description	Default	Modify
		 <p>Setting range: 0.0–3600.0s (valid when P01.21=1)</p>		
P01.23	Start delay time	The function determines the brake release after the running command is given, and the VFD is in a stand-by state and wait for the delay time set by P01.23 Setting range: 0.0–60.0s	0.0s	<input type="radio"/>
P01.24	Delay of stopping speed	Setting range: 0.0–100.0s	0.0s	<input type="radio"/>
P01.25	0Hz output	Select the 0Hz output of the VFD. 0: No voltage output 1: With voltage output 2: Output at stop DC brake current	0	<input type="radio"/>

P02 group Motor 1 parameters

Function code	Name	Description	Default	Modify
P02.01	Rated power of async-motor	0.1–3000.0kW	Depend on model	<input checked="" type="radio"/>
P02.02	Rated frequency of async-motor	0.01Hz–P00.03	50.00Hz	<input checked="" type="radio"/>
P02.03	Rated speed of async-motor	1–60000rpm	Depend on model	<input checked="" type="radio"/>
P02.04	Rated voltage of async-motor	0–1200V	Depend on model	<input checked="" type="radio"/>
P02.05	Rated current of async-motor	0.8–6000.0A	Depend on	<input checked="" type="radio"/>

Function code	Name	Description	Default	Modify
			model	
P02.06	Stator resistor of async-motor	0.001–65.535Ω	Depend on model	<input type="radio"/>
P02.07	Rotor resistor of async-motor	0.001–65.535Ω	Depend on model	<input type="radio"/>
P02.08	Leakage inductance of async-motor	0.1–6553.5mH	Depend on model	<input type="radio"/>
P02.09	Mutual inductance of async-motor	0.1–6553.5mH	Depend on model	<input type="radio"/>
P02.10	Non-load current of async-motor	0.1–6553.5A	Depend on model	<input type="radio"/>
P02.11	Magnetic saturation coefficient 1 for iron core of async-motor 1	0.0–100.0%	80.0%	<input checked="" type="radio"/>
P02.12	Magnetic saturation coefficient 2 for iron core of async-motor 1	0.0–100.0%	68.0%	<input checked="" type="radio"/>
P02.13	Magnetic saturation coefficient 3 for iron core of async-motor 1	0.0–100.0%	57.0%	<input checked="" type="radio"/>
P02.14	Magnetic saturation coefficient 4 for the iron core of async-motor 1	0.0–100.0%	40.0%	<input checked="" type="radio"/>

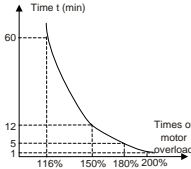
Function code	Name	Description	Default	Modify
P02.26	Motor overload protection selection	<p>0: No protection</p> <p>1: Common motor (with low speed compensation). Because the heat-releasing effect of the common motors will be weakened, the corresponding electric heat protection will be adjusted properly. The low speed compensation characteristic mentioned here means reducing the threshold of the overload protection of the motor whose running frequency is below 30Hz.</p> <p>2: Frequency conversion motor (without low speed compensation). Because the heat-releasing of the specific motors won't be impacted by the rotation speed, it is not necessary to adjust the protection value during low-speed running.</p>	2	⊙
P02.27	Motor overload protection coefficient	<p>Times of motor overload $M = I_{out}/(I_n * K)$</p> <p>I_n is the rated current of the motor, I_{out} is the output current of the VFD and K is the motor protection coefficient.</p> <p>So, the bigger the value of K is, the smaller the value of M is. When $M=116\%$, protection is performed after motor overload lasts for 1 hour; when $M=150\%$, protection is performed after motor overload lasts for 12 minutes; when $M=180\%$, protection is performed after motor overload lasts for 5 minutes; when $M=200\%$, protection is performed after motor overload lasts for 60 seconds; and when $M \geq 400\%$, protection is performed immediately.</p> 	100.0%	○
		Setting range: 20.0%–120.0%		

Function code	Name	Description	Default	Modify
P02.28	Correction coefficient of motor 1 power	Correct the power displaying of motor 1. Only impact the displaying value other than the control performance of the VFD. Setting range: 0.00–3.00	1.00	<input type="radio"/>

P03 group Vector control

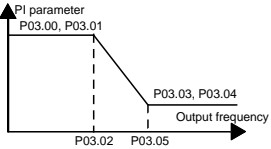
Function code	Name	Description	Default	Modify
P03.00	Speed loop proportional gain 1	<p>The parameters P03.00–P03.05 only apply to vector control mode. Below the switching frequency 1 (P03.02), the speed loop PI parameters are: P03.00 and P03.01. Above the switching frequency 2 (P03.05), the speed loop PI parameters are: P03.03 and P03.04. PI parameters are gained according to the linear change of two groups of parameters. It is shown as below:</p> 	20.0	<input type="radio"/>
P03.01	Speed loop integral time 1		0.200s	<input type="radio"/>
P03.02	Switching low point frequency		5.00Hz	<input type="radio"/>
P03.03	Speed loop proportional gain 2		20.0	<input type="radio"/>
P03.04	Speed loop integral time 2		0.200s	<input type="radio"/>
P03.05	Switching high point frequency	<p>PI has a close relationship with the inertia of the system. Adjust on the base of PI according to different loads to meet various demands. Setting range of P03.00 and P03.03: 0–200.0 Setting range of P03.01 and P03.04: 0.000–10.000s Setting range of P03.02: 0.00Hz–P00.05 Setting range of P03.05: P03.02–P00.03</p>	10.00Hz	<input type="radio"/>
P03.06	Speed loop output filter	0–8 (corresponds to 0–2 ⁸ /10ms)	0	<input type="radio"/>
P03.07	Compensation coefficient of vector control electromotion	Slip compensation coefficient is used to adjust the slip frequency of the vector control and improve the speed control accuracy of the system. Adjusting the parameter properly can	100%	<input type="radio"/>

Function code	Name	Description	Default	Modify
	slip	control the speed steady-state error. Setting range: 50%–200%		
P03.08	Compensation coefficient of vector control brake slip		100%	<input type="radio"/>
P03.09	Current loop proportional coefficient P	Note: ✧ The two function codes impact the dynamic response speed and control accuracy of the system. Generally, you do not need to modify the two function codes.	1000	<input type="radio"/>
P03.10	Current loop integral coefficient I	✧ The parameters P03.09 and P03.10 are applicable only to SVC 0 (P00.00=0). Setting range: 0–65535	1000	<input type="radio"/>
P03.11	Torque setting mode selection	This parameter is used to enable the torque control mode, and set the torque setting means. 0: Torque control is invalid 1: Set via keypad (P03.12) 2: Set via AI1 (100% relative to three times of motor current) 3: Set via AI2 (100% relative to three times of motor) (same as above) 4: Set via AI3 (100% relative to three times of motor) (same as above) 5: Set via pulse frequency HDI (same as above) 6: Multi-step torque setting (same as above) 7: Set via Modbus communication 8–10: Reserved Note: Setting mode 2–7, 100% corresponds to 3 times of the motor rated current	0	<input type="radio"/>
P03.12	Keypad setting torque	Setting range: -300.0%–300.0% (motor rated current)	50.0%	<input type="radio"/>
P03.13	Torque reference filter time	0.000–10.000s	0.100s	<input type="radio"/>
P03.14	Setting source of upper-limit frequency of forward	0: Set via keypad (P03.16 sets P03.14, P03.17 sets P03.15) 1: Set via AI1 (100% corresponds to max. frequency)	0	<input type="radio"/>

Function code	Name	Description	Default	Modify
	rotation in torque control	2: Set via AI2 (same as above) 3: Set via AI3 (same as above) 4: Set via pulse frequency HDI (same as above)		
P03.15	Setting source of upper-limit frequency of reverse rotation in torque control	5: Set via multi-step (same as above) 6: Set via Modbus communication (same as above) 7-9: Reserved Note: setting method 1-9, 100% corresponds to the maximum frequency	0	<input type="radio"/>
P03.16	Torque control forward rotation upper-limit frequency keypad limit value	This function is used to set the upper limit of the frequency. P03.16 sets the value of P03.14; P03.17 sets the value of P03.15. Setting range: 0.00 Hz-P00.03 (the max. output frequency)	50.00 Hz	<input type="radio"/>
P03.17	Torque control reverse rotation upper-limit frequency keypad limit value		50.00 Hz	<input type="radio"/>
P03.18	Upper-limit setting of electromotion torque	This function code is used to select the electromotion and braking torque upper-limit setting source selection. 0: Set via keypad (P03.20 sets P03.18 and P03.21 sets P03.19)	0	<input type="radio"/>
P03.19	Upper-limit setting of braking torque	1: Set via AI1 (100% relative to three times of motor current) 2: Set via AI2 (same as above) 3: Set via AI3 (same as above) 4: Set via HDI (same as above) 5: Set via Modbus communication (same as above) 6-8: Reserved Note: Setting mode 1-8, 100% corresponds to three times of the motor current.	0	<input type="radio"/>

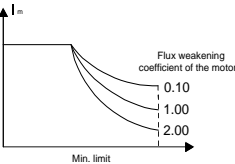
Function code	Name	Description	Default	Modify
P03.20	Electromotion torque upper-limit setting via keypad	The function code is used to set the limit of the torque. Setting range: 0.0–300.0% (motor rated current)	180.0%	<input type="radio"/>
P03.21	Braking torque upper-limit setting via keypad		180.0%	<input type="radio"/>
P03.22	Flux weakening coefficient in constant power zone	The usage of motor in flux weakening control. Function code P03.22 and P03.23 are effective at constant power. The motor will enter the flux weakening state when running at rated speed. Change the flux weakening curve by modifying the flux weakening control coefficient. The bigger the flux weakening control coefficient is, the steeper the weakening curve is. 	0.3	<input type="radio"/>
P03.23	The lowest flux weakening point in constant power zone		Setting range of P03.22: 0.1–2.0 Setting range of P03.23: 10%–100%	20%
P03.24	Max. voltage limit	This parameter sets the max. voltage of the VFD, which is dependent on the site situation. Setting range: 0.0–120.0%	100.0%	<input checked="" type="radio"/>
P03.25	Pre-exciting time	Pre-activate the motor when the VFD starts up. Build up a magnetic field inside the motor to improve the torque performance during the starting process. The setting time: 0.000–10.000s	0.300s	<input type="radio"/>
P03.26	Flux weakening proportional gain	0–8000	1200	<input type="radio"/>

Function code	Name	Description	Default	Modify
P03.27	Speed display selection of vector control	0: Display as per the actual value 1: Display as per the setting value	0	<input type="radio"/>
P03.28	Static friction compensation coefficient	0.0–100.0%	0.0%	<input type="radio"/>
P03.29	Dynamic friction compensation coefficient	0.0–100.0%	0.0%	<input type="radio"/>

P04 group SVPWM control

Function code	Name	Description	Default	Modify
P04.00	V/F curve setting of motor 1	<p>This function codes defines the V/F curve of Goodrive20-EU motor 1 to meet the need of different loads.</p> <p>0: Straight V/F curve; applying to the constant torque load</p> <p>1: Multi-points V/F curve</p> <p>2: Torque step-down V/F curve (1.3 order)</p> <p>3: Torque step-down V/F curve (1.7 order)</p> <p>4: Torque step-down V/F curve (2.0 order)</p> <p>Curves 2–4 apply to the torque loads such as fans and water pumps. Users can adjust according to the features of the loads to get the best performance.</p> <p>5: Customized V/F (V/F separation); in this mode, V can be separated from f and f can be adjusted through the frequency reference channel set by P00.06 or the voltage reference channel set by P04.27 to change the feature of the curve.</p> <p>Note: V_b in the below picture is the motor rated voltage and f_b is the motor rated frequency.</p>	0	<input checked="" type="radio"/>

Function code	Name	Description	Default	Modify
P04.01	Torque boost of motor 1	<p>Torque boost to the output voltage for the features of low frequency torque. P04.01 is for the max. output voltage V_b.</p> <p>P04.02 defines the percentage of closing frequency of manual torque to f_b.</p> <p>Torque boost should be selected according to the load. The bigger the load is, the bigger the torque is. Too big torque boost is inappropriate because the motor will run with over magnetic, and the current of the VFD will increase to add the temperature of the VFD and decrease the efficiency.</p>	0.0%	<input type="radio"/>
P04.02	Torque boost cut-off of motor 1	<p>When the torque boost is set to 0.0%, the VFD is automatic torque boost.</p> <p>Torque boost threshold: below this frequency point, the torque boost is valid, but over this frequency point, the torque boost is invalid.</p> <p>Setting range of P04.01: 0.0%: (automatic) 0.1%–10.0%</p> <p>Setting range of P04.02: 0.0%–50.0%</p>	20.0%	<input type="radio"/>
P04.03	V/F frequency point 1 of motor 1		0.00Hz	<input type="radio"/>
P04.04	V/F voltage point 1 of motor 1		0.0%	<input type="radio"/>

Function code	Name	Description	Default	Modify
P04.05	V/F frequency point 2 of motor 1	When P04.00 =1, the user can set V//F curve through P04.03–P04.08. V/F is generally set according to the load of the motor. Note: $V1 < V2 < V3$, $f1 < f2 < f3$. Too high low frequency voltage will heat the motor excessively or damage. Overcurrent stall or overcurrent protection may occur. Setting range of P04.03: 0.00Hz–P04.05 Setting range of P04.04, P04.06 and P04.08: 0.0%–110.0% (rated voltage of motor 1) Setting range of P04.05: P04.03–P04.07 Setting range of P04.07: P04.05–P02.02 (rated frequency of motor 1)	0.00Hz	<input type="radio"/>
P04.06	V/F voltage point 2 of motor 1		0.0%	<input type="radio"/>
P04.07	V/F frequency point 3 of motor 1		0.00Hz	<input type="radio"/>
P04.08	V/F voltage point 3 of motor 1		0.0%	<input type="radio"/>
P04.09	V/F slip compensation gain of motor 1	This function code is used to compensate the change of the rotation speed caused by load during compensation SVPWM control to improve the rigidity of the motor. It can be set to the rated slip frequency of the motor which is counted as below: $\Delta f = f_b \cdot n \cdot p / 60$ Of which, f_b is the rated frequency of the motor, its function code is P02.02; n is the rated rotating speed of the motor and its function code is P02.03; p is the pole pair of the motor. 100.0% corresponds to the rated slip frequency Δf . Setting range: 0.0–200.0%	100.0%	<input type="radio"/>
P04.10	Low frequency vibration control factor of motor 1	In the SVPWM control mode, current fluctuation may occur to the motor on some frequency, especially the motor with big power. The motor cannot run stably or overcurrent may occur. These phenomena can be canceled by adjusting this parameter. Setting range of P04.10: 0–100 Setting range of P04.11: 0–100 Setting range of P04.12: 0.00Hz–P00.03 (the max. frequency)	10	<input type="radio"/>
P04.11	High frequency vibration control factor of motor 1		10	<input type="radio"/>
P04.12	Vibration control threshold of		30.00 Hz	<input type="radio"/>

Function code	Name	Description	Default	Modify
	motor 1			
P04.26	Energy-saving operation selection	0: No operation 1: Automatic energy-saving operation Motor on the light load conditions, automatically adjusts the output voltage to save energy	0	☉
P04.27	Voltage Setting channel	Select the output setting channel at V/F curve separation. 0: Set via keypad: the output voltage is determined by P04.28. 1: Set via AI1 2: Set via AI2 3: Set via AI3 4: Set via HDI 5: Set via multi-step (the set value is determined by the multi-step speed in P10 group) 6: Set via PID 7: Set via Modbus communication 8–10: Reserved Note: 100% corresponds to the rated voltage of the motor.	0	○
P04.28	Voltage value set via keypad	This function code is the voltage digital set value when the voltage setting channel is selected as "keypad selection" Setting range: 0.0%–100.0%	100.0%	○
P04.29	Voltage increase time	Voltage increasing time is the time when the VFD accelerates from the output minimum voltage to the output maximum voltage.	5.0s	○
P04.30	Voltage decrease time	Voltage decreasing time is the time when the VFD decelerates from the output maximum voltage to the output minimum voltage. Setting range: 0.0–3600.0s	5.0s	○
P04.31	Output maximum voltage	Set the upper and low limit of the output voltage. Setting range of P04.31: P04.32–100.0% (the rated voltage of the motor)	100.0%	☉
P04.32	Output minimum voltage	Setting range of P04.32: 0.0%–P04.31 (the rated voltage of the motor)	0.0%	☉

Function code	Name	Description	Default	Modify
P04.33	Flux weakening coefficient in constant power zone	<p>Adjust the output voltage of the VFD in SVPWM mode during flux weakening.</p> <p>Note: Invalid in the constant torque mode.</p> <p>Setting range of P04.33: 1.00–1.30</p>	1.00	○

P05 group Input terminals

Function code	Name	Description	Default	Modify
P05.00	HDI input selection	0: HDI is high pulse input. See P05.50–P05.54 1: HDI is switch input	0	⊙
P05.01	S1 terminal function selection	<p>Note: S1–S4, HDI are the upper terminals on the control board and P05.12 can be used to set the function of S5–S8</p> <p>0: No function 1: Forward rotation operation 2: Reverse rotation operation 3: Tri-linear running control 4: Forward jogging 5: Reverse jogging 6: Coast to stop 7: Fault reset 8: Operation pause 9: External fault input</p>	1	⊙
P05.02	S2 terminal function selection		4	⊙
P05.03	S3 terminal function selection		7	⊙
P05.04	S4 terminal function selection		0	⊙

Function code	Name	Description	Default	Modify
P05.05	S5 terminal function selection	10: Increasing frequency setting (UP) 11: Decreasing frequency setting (DOWN) 12: Cancel the frequency change setting	0	⊙
P05.06	S6 terminal function selection	13: Shift between A setting and B setting 14: Shift between combination setting and A setting 15: Shift between combination setting and B setting	0	⊙
P05.07	S7 terminal function selection	16: Multi-step speed terminal 1 17: Multi-step speed terminal 2	0	⊙
P05.08	S8 terminal function selection	18: Multi-step speed terminal 3 19: Multi-step speed terminal 4 20: Multi-step speed pause	0	⊙
P05.09	HDI terminal function selection	21: ACC/DEC time selection terminal 1 22: ACC/DEC time selection terminal 2 23: Simple PLC stop reset 24: Simple PLC pause 25: PID control pause 26: Wobbling frequency pause (stop at present frequency) 27: Wobbling frequency reset (return to center frequency) 28: Counter reset 29: Torque control prohibition 30: ACC/DEC prohibition 31: Counter trigger 32: Reserved 33: Cancel the frequency change setting temporarily 34: DC brake 35: Reserved 36: Shift the command to keypad 37: Shift the command to terminals 38: Shift the command to communication 39: Pre-magnetized command 40: Clear the power consumption 41: Keep the power consumption 42: Emergency stop 43-60: Reserved	0	⊙

Function code	Name	Description	Default	Modify																				
		61: PID pole switching 62–63: Reserved When the terminal acts as ACC/DEC time selection, you need to select four groups of ACC/DEC time through state combinations of these two terminals.																						
		<table border="1"> <thead> <tr> <th>Terminal 1 (21)</th> <th>Terminal 2 (22)</th> <th>ACC/DEC time setting</th> <th>Parameters</th> </tr> </thead> <tbody> <tr> <td>OFF</td> <td>OFF</td> <td>ACC/DEC time 1</td> <td>P00.11/ P00.12</td> </tr> <tr> <td>ON</td> <td>OFF</td> <td>ACC/DEC time 2</td> <td>P08.00/ P08.01</td> </tr> <tr> <td>OFF</td> <td>ON</td> <td>ACC/DEC time 3</td> <td>P08.02/ P08.03</td> </tr> <tr> <td>ON</td> <td>ON</td> <td>ACC/DEC time 4</td> <td>P08.04/ P08.05</td> </tr> </tbody> </table>	Terminal 1 (21)	Terminal 2 (22)	ACC/DEC time setting	Parameters	OFF	OFF	ACC/DEC time 1	P00.11/ P00.12	ON	OFF	ACC/DEC time 2	P08.00/ P08.01	OFF	ON	ACC/DEC time 3	P08.02/ P08.03	ON	ON	ACC/DEC time 4	P08.04/ P08.05		
Terminal 1 (21)	Terminal 2 (22)	ACC/DEC time setting	Parameters																					
OFF	OFF	ACC/DEC time 1	P00.11/ P00.12																					
ON	OFF	ACC/DEC time 2	P08.00/ P08.01																					
OFF	ON	ACC/DEC time 3	P08.02/ P08.03																					
ON	ON	ACC/DEC time 4	P08.04/ P08.05																					
P05.10	Input terminal polarity selection	The function code is used to set the polarity of the input terminals. Set the bit to 0, the input terminal is anode. Set the bit to 1, the input terminal is cathode.	0x000	○																				
		<table border="1"> <thead> <tr> <th>BIT8</th> <th>BIT7</th> <th>BIT6</th> <th>BIT5</th> <th>BIT4</th> </tr> </thead> <tbody> <tr> <td>HDI</td> <td>S8</td> <td>S7</td> <td>S6</td> <td>S5</td> </tr> <tr> <th>BIT3</th> <th>BIT2</th> <th>BIT1</th> <th>BIT0</th> <td></td> </tr> <tr> <td>S4</td> <td>S3</td> <td>S2</td> <td>S1</td> <td></td> </tr> </tbody> </table> Setting range: 0x000–0x1FF	BIT8	BIT7	BIT6	BIT5	BIT4	HDI	S8	S7	S6	S5	BIT3	BIT2	BIT1	BIT0		S4	S3	S2	S1			
BIT8	BIT7	BIT6	BIT5	BIT4																				
HDI	S8	S7	S6	S5																				
BIT3	BIT2	BIT1	BIT0																					
S4	S3	S2	S1																					
P05.11	Switch filter time	Set the sample filter time of S1–S4 and HDI terminals. If the interference is strong, increase the parameter to avoid wrong operation. 0.000–1.000s	0.010s	○																				
P05.12	Virtual terminal setting	0x000–0x1FF (0: Disabled, 1: Enabled) BIT0: S1 virtual terminal BIT1: S2 virtual terminal BIT2: S3 virtual terminal BIT3: S4 virtual terminal BIT4: S5 virtual terminal BIT5: S6 virtual terminal BIT6: S7 virtual terminal BIT7: S8 virtual terminal BIT8: HDI virtual terminal	0x000	◎																				

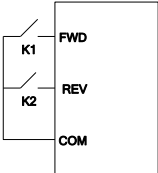
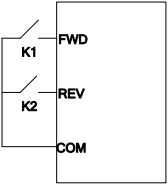
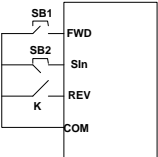
Function code	Name	Description	Default	Modify																														
		Note: After a virtual terminal is enabled, the state of the terminal can only be modified through communication, and the communication address is 0x200A.																																
P05.13	Terminal control running mode	<p>Set the operation mode of the terminals control 0: 2-wire control 1; Combine the enable with the direction. This mode is widely used. It determines the rotation direction by the defined FWD and REV terminals command.</p>  <table border="1" data-bbox="578 448 758 672"> <thead> <tr> <th>FWD</th> <th>REV</th> <th>Running command</th> </tr> </thead> <tbody> <tr> <td>OFF</td> <td>OFF</td> <td>Stopping</td> </tr> <tr> <td>ON</td> <td>OFF</td> <td>Forward running</td> </tr> <tr> <td>OFF</td> <td>ON</td> <td>Reverse running</td> </tr> <tr> <td>ON</td> <td>ON</td> <td>Hold on</td> </tr> </tbody> </table> <p>1: 2-wire control 2; Separate the enable from the direction. FWD defined by this mode is the enabling ones. The direction depends on the state of the defined REV.</p>  <table border="1" data-bbox="578 803 768 1041"> <thead> <tr> <th>FWD</th> <th>REV</th> <th>Running command</th> </tr> </thead> <tbody> <tr> <td>OFF</td> <td>OFF</td> <td>Stopping</td> </tr> <tr> <td>ON</td> <td>OFF</td> <td>Forward running</td> </tr> <tr> <td>OFF</td> <td>ON</td> <td>Stopping</td> </tr> <tr> <td>ON</td> <td>ON</td> <td>Reverse running</td> </tr> </tbody> </table> <p>2: 3-wire control 1; Sin is the enabling terminal in this mode, and the running command is caused by FWD and the direction is controlled by REV. Sin is natural closed.</p> 	FWD	REV	Running command	OFF	OFF	Stopping	ON	OFF	Forward running	OFF	ON	Reverse running	ON	ON	Hold on	FWD	REV	Running command	OFF	OFF	Stopping	ON	OFF	Forward running	OFF	ON	Stopping	ON	ON	Reverse running	0	⊙
FWD	REV	Running command																																
OFF	OFF	Stopping																																
ON	OFF	Forward running																																
OFF	ON	Reverse running																																
ON	ON	Hold on																																
FWD	REV	Running command																																
OFF	OFF	Stopping																																
ON	OFF	Forward running																																
OFF	ON	Stopping																																
ON	ON	Reverse running																																

Function code	Name	Description	Default	Modify																																									
		<p>The direction control is as follows during operation:</p> <table border="1"> <thead> <tr> <th>SIn</th> <th>REV</th> <th>Previous direction</th> <th>Current direction</th> </tr> </thead> <tbody> <tr> <td rowspan="2">ON</td> <td rowspan="2">OFF→ON</td> <td>Forward</td> <td>Reverse</td> </tr> <tr> <td>Reverse</td> <td>Forward</td> </tr> <tr> <td rowspan="2">ON</td> <td rowspan="2">ON→OFF</td> <td>Reverse</td> <td>Forward</td> </tr> <tr> <td>Forward</td> <td>Reverse</td> </tr> <tr> <td rowspan="2">ON→ OFF</td> <td>ON</td> <td colspan="2" rowspan="2">Decelerate to stop</td> </tr> <tr> <td>OFF</td> </tr> </tbody> </table> <p>3: 3-wire control 2; SIn is the enabling terminal in this mode, and the running command is caused by SB1 or SB3 and both of them control the running direction. NC SB2 generates the stop command.</p> <table border="1"> <thead> <tr> <th>SIn</th> <th>FWD</th> <th>REV</th> <th>Direction</th> </tr> </thead> <tbody> <tr> <td rowspan="2">ON</td> <td rowspan="2">OFF→ON</td> <td>ON</td> <td>Forward</td> </tr> <tr> <td>OFF</td> <td>Reverse</td> </tr> <tr> <td rowspan="2">ON</td> <td>ON</td> <td rowspan="2">OFF→ON</td> <td>Forward</td> </tr> <tr> <td>OFF</td> <td>Reverse</td> </tr> <tr> <td>ON→ OFF</td> <td></td> <td></td> <td>Decelerate to stop</td> </tr> </tbody> </table> <p>Note: For the 2-wire running mode, when FWD/REV terminal is valid, the VFD stop because of the stopping command from other sources, even the control terminal FWD/REV keeps valid; the VFD won't work when the stopping command is canceled. Only when FWD/REV is re-launched, the VFD can start again. For example, the valid STOP/RST stop</p>	SIn	REV	Previous direction	Current direction	ON	OFF→ON	Forward	Reverse	Reverse	Forward	ON	ON→OFF	Reverse	Forward	Forward	Reverse	ON→ OFF	ON	Decelerate to stop		OFF	SIn	FWD	REV	Direction	ON	OFF→ON	ON	Forward	OFF	Reverse	ON	ON	OFF→ON	Forward	OFF	Reverse	ON→ OFF			Decelerate to stop		
SIn	REV	Previous direction	Current direction																																										
ON	OFF→ON	Forward	Reverse																																										
		Reverse	Forward																																										
ON	ON→OFF	Reverse	Forward																																										
		Forward	Reverse																																										
ON→ OFF	ON	Decelerate to stop																																											
	OFF																																												
SIn	FWD	REV	Direction																																										
ON	OFF→ON	ON	Forward																																										
		OFF	Reverse																																										
ON	ON	OFF→ON	Forward																																										
	OFF		Reverse																																										
ON→ OFF			Decelerate to stop																																										

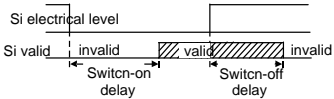
Function code	Name	Description	Default	Modify
		when PLC signal cycles stop, fixed-length stop and terminal control (see P07.04).		
P05.14	S1 terminal switching on delay time	<p>The function code defines the corresponding delay time of electrical level of the programmable terminals from switching on to switching off.</p>  <p>Setting range: 0.000–50.000s</p>	0.000s	○
P05.15	S1 terminal switching off delay time		0.000s	○
P05.16	S2 terminal switching on delay time		0.000s	○
P05.17	S2 terminal switching off delay time		0.000s	○
P05.18	S3 terminal switching on delay time		0.000s	○
P05.19	S3 terminal switching off delay time		0.000s	○
P05.20	S4 terminal switching on delay time		0.000s	○
P05.21	S4 terminal switching off delay time		0.000s	○
P05.30	HDI terminal switching on delay time		0.000s	○
P05.31	HDI terminal switching off delay time		0.000s	○
P05.32	Lower limit of AI1	AI1 is set by the analog potentiometer, AI2 is set by control terminal AI2 and AI3 is set by control terminal AI3. The function code defines the relationship between the analog input voltage and its corresponding set value. If the analog	0.00V	○
P05.33	Corresponding setting of the lower limit of		0.0%	○

Function code	Name	Description	Default	Modify
	AI1	input voltage beyond the set minimum or maximum input value, the VFD will count at the minimum or maximum one.		
P05.34	Upper limit of AI1		10.00V	<input type="radio"/>
P05.35	Corresponding setting of the upper limit of AI1	When the analog input is the current input, the corresponding voltage of 0–20mA is 0–10V. In different cases, the corresponding rated value of 100.0% is different. See the application for detailed information.	100.0%	<input type="radio"/>
P05.36	AI1 input filter time	The figure below illustrates different applications:	0.100s	<input type="radio"/>
P05.37	Lower limit of AI2		0.00V	<input type="radio"/>
P05.38	Corresponding setting of the lower limit of AI2		0.0%	<input type="radio"/>
P05.39	Upper limit of AI2		10.00V	<input type="radio"/>
P05.40	Corresponding setting of the upper limit of AI2		100.0%	<input type="radio"/>
P05.41	AI2 input filter time	Input filter time: this parameter is used to adjust the sensitivity of the analog input. Increasing the value properly can enhance the anti-interference of the analog, but weaken the sensitivity of the analog input	0.100s	<input type="radio"/>
P05.42	Lower limit of AI3	Note: AI1 supports 0–10V input and AI2 supports 0–10V or 0–20mA input, when AI2 selects 0–20mA input, the corresponding voltage of 20mA is 10V. AI3 can support the output of -10V→+10V.	-10.00V	<input type="radio"/>
P05.43	Corresponding setting of the lower limit of AI3		-100.0%	<input type="radio"/>
P05.44	Middle value of AI3	Setting range of P05.32: 0.00V–P05.34 Setting range of P05.33: -100.0%–100.0%	0.00V	<input type="radio"/>
P05.45	Corresponding middle setting of AI3	Setting range of P05.34: P05.32–10.00V Setting range of P05.35: -100.0%–100.0%	0.0%	<input type="radio"/>
P05.46	Upper limit of AI3	Setting range of P05.36: 0.000s–10.000s Setting range of P05.37: 0.00V–P05.39	10.00V	<input type="radio"/>
P05.47	Corresponding setting of	Setting range of P05.38: -100.0%–100.0% Setting range of P05.39: P05.37–10.00V Setting range of P05.40: -100.0%–100.0%	100.0%	<input type="radio"/>

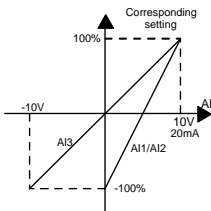

Function code	Name	Description	Default	Modify
	the upper limit of AI3	Setting range of P05.41: 0.000s–10.000s Setting range of P05.42: -10.00V–P05.44		
P05.48	AI3 input filter time	Setting range of P05.43: -100.0%–100.0% Setting range of P05.44: P05.42–P05.46 Setting range of P05.45: -100.0%–100.0% Setting range of P05.46: P05.44–10.00V Setting range of P05.48: 0.000s–10.000s	0.100s	<input type="radio"/>
P05.50	Lower limit frequency of HDI	0.000kHz–P05.52	0.000 kHz	<input type="radio"/>
P05.51	Corresponding setting of HDI low frequency setting	-100.0%–100.0%	0.0%	<input type="radio"/>
P05.52	Upper limit frequency of HDI	P05.50–50.000kHz	50.000 kHz	<input type="radio"/>
P05.53	Corresponding setting of upper limit frequency of HDI	-100.0%–100.0%	100.0%	<input type="radio"/>
P05.54	HDI frequency input filter time	0.000s–10.000s	0.100s	<input type="radio"/>

P06 group Output terminals

Function code	Name	Description	Default	Modify
P06.01	Y1 output selection	0: Invalid 1: In operation	0	<input type="radio"/>
P06.03	Relay RO1 output selection	2: Forward rotation operation 3: Reverse rotation operation 4: Jogging operation 5: The VFD fault	1	<input type="radio"/>
P06.04	Relay RO2 output selection	6: Frequency level test FDT1 7: Frequency level test FDT2 8: Frequency reached	5	<input type="radio"/>

Function code	Name	Description	Default	Modify								
		9: In zero-speed operation (output in running state) 10: Upper limit frequency reached 11: Lower limit frequency reached 12: Ready for operation 13: Pre-magnetizing 14: Overload pre-alarm 15: Underload pre-alarm 16: Completion of simple PLC stage 17: Completion of simple PLC cycle 18: Setting count value arrival 19: Defined count value arrival 20: External fault valid 21: Zero-speed output (output in both running and stopping states) 22: Running time arrival 23: Modbus communication virtual terminals output 24–25: Reserved 26: Establishment of DC bus voltage 27: STO action 28–30: Reserved										
P06.05	Polarity selection of output terminals	The function code is used to set the pole of the output terminal. When the current bit is set to 0, input terminal is positive. When the current bit is set to 1, input terminal is negative. <table border="1" data-bbox="311 1035 806 1103"> <tr> <td>BIT3</td> <td>BIT2</td> <td>BIT1</td> <td>BIT0</td> </tr> <tr> <td>RO2</td> <td>RO1</td> <td>Reserved</td> <td>Y1</td> </tr> </table> Setting range: 0x00–0x0F	BIT3	BIT2	BIT1	BIT0	RO2	RO1	Reserved	Y1	0x00	○
BIT3	BIT2	BIT1	BIT0									
RO2	RO1	Reserved	Y1									
P06.06	Y1 switch-on delay	Setting range: 0.000–50.000s	0.000s	○								
P06.07	Y1 switch-off delay	Setting range: 0.000–50.000s	0.000s	○								
P06.10	RO1 switch-on delay	The function code defines the corresponding delay time of the electrical level change during the programmable terminal switching on and off.	0.000s	○								
P06.11	RO1 switch-off delay		0.000s	○								

Function code	Name	Description	Default	Modify
P06.12	RO2 switch-on delay		0.000s	<input type="radio"/>
P06.13	RO2 switch-off delay		0.000s	<input type="radio"/>
		Setting range: 0.000–50.000s		
P06.14	AO1 output	0: Running frequency	0	<input type="radio"/>
P06.15	AO2 output	1: Set frequency 2: Ramp reference frequency 3: Running speed (relative to twice the motor synchronous rotational speed) 4: Output current (relative to twice the rated VFD current) 5: Output current (relative to twice the rated motor current) 6: Output voltage (relative to 1.5 times the rated VFD voltage) 7: Output power (relative to twice the rated motor power) 8: Set torque value (relative to twice the rated motor torque) 9: Output torque (relative to twice the rated motor torque) 10: Analog AI1 input value 11: Analog AI2 input value 12: Analog AI3 input value 13: High-speed pulse HDIA input value 14: Value 1 set through Modbus communication 15: Value 2 set through Modbus communication 16–21: Reserved 22: Torque current (relative to 3 times the rated motor current) 23: Ramp reference frequency 24: Source output at constant current 25–30: Reserved	0	<input type="radio"/>
P06.17	Lower limit of AO1 output	The above function codes define the relative relation between the output value and analog	0.0%	<input type="radio"/>

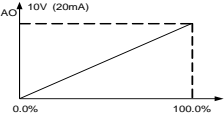
Function code	Name	Description	Default	Modify	
P06.18	Corresponding AO1 output to the lower limit	<p>output. When the output value exceeds the range of set maximum or minimum output, it will count according to the low-limit or upper-limit output.</p> <p>When the analog output is current output, 1mA equals to 0.5V.</p> <p>In different cases, the corresponding analog output of 100% of the output value is different. Refer to each application for detailed information.</p> 	0.00V	<input type="radio"/>	
P06.19	Upper limit of AO1 output		100.0%	<input type="radio"/>	
P06.20	Corresponding AO1 output of the upper limit		10.00V	<input type="radio"/>	
P06.21	AO1 output filter time		0.000s	<input type="radio"/>	
P06.22	Lower limit of AO2 output		0.0%	<input type="radio"/>	
P06.23	Corresponding AO2 output to the lower limit		0.00V	<input type="radio"/>	
P06.24	Upper limit of AO2 output		Setting range of P06.17: -100.0%– P06.19 Setting range of P06.18: 0.00V–10.00V	100.0%	<input type="radio"/>
P06.25	Corresponding AO2 output to the upper limit		Setting range of P06.19: P06.17–100.0% Setting range of P06.20: 0.00V–10.00V Setting range of P06.21: 0.000s–10.000s	10.00V	<input type="radio"/>
P06.26	AO2 output filter time		Setting range of P06.22:- 100.0%– P06.24 Setting range of P06.23: 0.00V–10.00V Setting range of P06.24: P06.22–100.0% Setting range of P06.25: 0.00V–10.00V Setting range of P06.26: 0.000s–10.000s	0.000s	<input type="radio"/>

P07 group HMI

Function code	Name	Description	Default	Modify
P07.00	User password	<p>0–65535</p> <p>The password protection will be valid when setting any non-zero number.</p> <p>00000: Clear the previous user's password, and make the password protection invalid.</p> <p>After the user's password becomes valid, if the password is incorrect, users cannot enter the parameter menu. Only correct password can make the user check or modify the parameters.</p>	0	<input type="radio"/>

Function code	Name	Description	Default	Modify
		<p>Please remember all users' passwords. Retreat editing state of the function codes and the password protection will become valid in 1 minute. If the password is available, press PRG/ESC to enter into the editing state of the function codes, and then "0.0.0.0.0" will be displayed. Unless input right password, the operator cannot enter into it.</p> <p>Note: Restoring to the default value can clear the password, please use it with caution.</p>		
P07.01	Parameter copy	<p>0: No operation 1: Upload the local function parameter to the keypad 2: Download the keypad function parameter to local address (including the motor parameters) 3: Download the keypad function parameter to local address (excluding the motor parameter of P02 and P12 group) 4: Download the keypad function parameters to local address (only for the motor parameter of P02 and P12 group)</p> <p>Note: After finish 1–4, the parameter will restore to 0 and the uploading and downloading does not include P29.</p>	0	☉
P07.02	Key function selection	<p>0x00–0x27 Ones place: QUICK/JOG key function 0: Null 1: Jogging 2: Switch display state via shift key 3: Switch between FWD/REV rotation 4: Clear UP/DOWN setting 5: Coast to stop 6: Switch running command ref. mode in order 7: Quick commission mode (based on non-default parameter)</p> <p>Tens place: 0: keys unlocked 1: Lock all keys</p>	0x01	☉

Function code	Name	Description	Default	Modify
		2: Lock part of the keys (lock PRG/ESC key only)		
P07.03	QUICK the shifting sequence of running command	When the ones place of P07.02=6, set the shifting sequence of running command channels. 0: Keypad control→terminals control →communication control 1: Keypad control←→terminals control 2: Keypad control←→communication control 3: Terminals control←→communication control	0	○
P07.04	STOP/RST stop function	Select the stop function by STOP/RST . STOP/RST is effective in any state for the keypad reset. 0: Only valid for the keypad control 1: Both valid for keypad and terminals control 2: Both valid for keypad and communication control 3: Valid for all control modes	0	○
P07.05	Displayed parameters 1 of running state	0x0000–0xFFFF BIT0: Running frequency (Hz on) BIT1: Set frequency (Hz flickering) BIT2: Bus voltage (V on) BIT3: Output voltage (V on) BIT4: Output current (A on) BIT5: Running rotation speed (rpm on) BIT6: Output power (% on) BIT7: Output torque (% on) BIT8: PID reference (% flickering) BIT9: PID feedback value (% on) BIT10: Input terminals state BIT11: Output terminals state BIT12: Torque set value (% on) BIT13: Pulse counter value BIT14: Reserved BIT15: PLC and the current step of multi-step speed	0x03FF	○
P07.06	Displayed parameters 2	0x0000–0xFFFF BIT0: Analog A11 value (V on)	0x0000	

Function code	Name	Description	Default	Modify
	of running state	BIT1: Analog AI2 value (V on) BIT2: Analog AI3 value (V on) BIT3: High speed pulse HDI frequency BIT4: Motor overload percentage (% on) BIT5: The VFD overload percentage (% on) BIT6: Ramp frequency reference (Hz on) BIT7: Linear speed BIT8: AC inlet current (A on) BIT9–15: Reserved		
P07.07	The parameter selection of the stop state	0x0000–0xFFFF BIT0: Set frequency (Hz on, frequency flickering slowly) BIT1: Bus voltage (V on) BIT2: Input terminals state BIT3: Output terminals state BIT4: PID reference (% flickering) BIT5: PID feedback value (% on) BIT6: Torque reference (% flickering) BIT7: AI1 (V on) BIT8: AI2 (V on) BIT9: AI3 (V on) BIT10: High-speed pulse HDI frequency BIT11: PLC and the current step of multi-step speed BIT12: Pulse counters BIT13–BIT15: Reserved	0x00FF	<input type="radio"/>
P07.08	Frequency display coefficient	0.01–10.00 Displayed frequency=running frequency* P07.08	1.00	<input type="radio"/>
P07.09	Speed display coefficient	0.1–999.9% Mechanical rotation speed =120 x (Displayed running frequency) x P07.09/(Number of motor poles)	100.0%	<input type="radio"/>
P07.10	Linear speed displayed coefficient	0.1–999.9% Linear speed= Mechanical rotation speedxP07.10	1.0%	<input type="radio"/>
P07.11	Rectifier bridge	-20.0–120.0°C	0.0°C	<input checked="" type="radio"/>

Function code	Name	Description	Default	Modify
	module temperature			
P07.12	Converter module temperature	-20.0–120.0°C	0.0°C	●
P07.13	Software version	1.00–655.35	Dependent on model	●
P07.14	Local accumulative running time	0–65535h	0h	●
P07.15	High bit of power consumption	Display the power used by the VFD. The power consumption of the VFD = P07.15×1000+P07.16	0kWh	●
P07.16	Low bit of power consumption	Setting range of P07.15: 0–65535kWh (*1000) Setting range of P07.16: 0.0–999.9kWh	0.0kWh	●
P07.18	Rated power of the VFD	0.4–3000.0kW	0.4kW	●
P07.19	Rated voltage of the VFD	50–1200V	380V	●
P07.20	Rated current of the VFD	0.1–6000.0A	0.1A	●
P07.21	Factory bar code 1	0x0000–0xFFFF	0xFFFF	●
P07.22	Factory bar code 2	0x0000–0xFFFF	0xFFFF	●
P07.23	Factory bar code 3	0x0000–0xFFFF	0xFFFF	●
P07.24	Factory bar code 4	0x0000–0xFFFF	0xFFFF	●
P07.25	Factory bar code 5	0x0000–0xFFFF	0xFFFF	●
P07.26	Factory bar code 6	0x0000–0xFFFF	0xFFFF	●
P07.27	Type of present fault	0: Reserved 1: Inverter unit U phase protection (OUt1)	0	●
P07.28	Type of the last fault	2: Inverter unit V phase protection (OUt2) 3: Inverter unit W phase protection (OUt3)	0	●

Function code	Name	Description	Default	Modify
P07.29	Type of the last but one fault	4: Overcurrent during acceleration (OC1)	0	●
P07.30	Type of the last but two fault	5: Overcurrent during deceleration (OC2)	0	●
P07.31	Type of the last but three fault	6: Overcurrent during constant speed running (OC3)	0	●
P07.32	Type of the last but four fault	7: Overvoltage during acceleration (OV1) 8: Overvoltage during deceleration (OV2) 9: Overvoltage during constant speed running (OV3) 10: Bus undervoltage (UV) 11: Motor overload (OL1) 12: VFD overload (OL2) 13: Phase loss on input side (SPI) 14: Phase loss on output side (SPO) 15: Rectifier module overheat (OH1) 16: Inverter module overheat (OH2) 17: External fault (EF) 18: 485 communication fault (CE) 19: Current detection fault (ItE) 20: Motor autotuning fault (tE) 21: EEPROM operation fault (EEP) 22: PID feedback offline fault (PIDE) 23: Braking unit fault (bCE) 24: Running time reached (END) 25: Electronic overload (OL3) 26: Keypad communication error (PCE) 27: Parameter upload error (UPE) 28: Parameter download error (DNE) 29–31: Reserved 32: To-ground short-circuit fault 1 (ETH1) 33: To-ground short-circuit fault 2 (ETH2) 34–35: Reserved 36: Underload fault (LL) 37: Safe torque off (STO) 38: Channel H1 abnormal (STL1) 39: Channel H2 abnormal (STL2) 40: Internal circuit abnormal (STL3) 41: Safety code FLASH CRC check fault (CrCE) 42: AIAO detected overtemperature (OH3)	0	●

Function code	Name	Description	Default	Modify
P07.33	Running frequency at present fault	0.00–400.00Hz	0.00Hz	●
P07.34	Ramp reference frequency at present fault	0.00–400.00Hz	0.00Hz	●
P07.35	Output voltage at present fault	0–1200V	0V	●
P07.36	Output current at present fault	0.0–6300.0A	0.0A	●
P07.37	Bus voltage at present fault	0.0–2000.0V	0.0V	●
P07.38	Temperature at present fault	0.0–120.0°C	0.0°C	●
P07.39	Input terminal state at present fault	0x0000–0xFFFF	0x0000	●
P07.40	Output terminal state at present fault	0x0000–0xFFFF	0x0000	●
P07.41	Reference frequency at the last fault	0.00–400.00Hz	0.00Hz	●
P07.42	Ramp reference frequency at the last fault	0.00–400.00Hz	0.00Hz	●
P07.43	Output voltage at last fault	0–1200V	0V	●
P07.44	Output current at last fault	0.0–6300.0A	0.0A	●
P07.45	Bus voltage at last fault	0.0–2000.0V	0.0V	●
P07.46	Temperature at last fault	0.0–120.0°C	0.0°C	●
P07.47	Input terminal state at last	0x0000–0xFFFF	0x0000	●

Function code	Name	Description	Default	Modify
	fault			
P07.48	Output terminal state at last fault	0x0000–0xFFFF	0x0000	●
P07.49	Running frequency at the last but one faults	0.00–400.00Hz	0.00Hz	●
P07.50	Ramp reference frequency at the last but one faults	0.00–400.00Hz	0.00Hz	●
P07.51	Output voltage at the last but one faults	0–1200V	0V	●
P07.52	Output current at the last but one faults	0.0–6300.0A	0.0A	●
P07.53	Bus voltage at the last but one faults	0.0–2000.0V	0.0V	●
P07.54	Temperature at the last but one faults	0.0–120.0°C	0.0°C	●
P07.55	Input terminal state at the last but one faults	0x0000–0xFFFF	0x0000	●
P07.56	Output terminal state at the last but one faults	0x0000–0xFFFF	0x0000	●

P08 group Enhanced functions

Function code	Name	Description	Default	Modify
P08.00	ACC time 2	When the terminal acts as ACC/DEC time selection (see terminal function settings in the	Depend on	○
P08.01	DEC time 2			○

Function code	Name	Description	Default	Modify																				
P08.02	ACC time 3	P05 group), you need to select four groups of ACC/DEC time through state combinations of these two terminals.	model	<input type="radio"/>																				
P08.03	DEC time 3			<input type="radio"/>																				
P08.04	ACC time 4			<input type="radio"/>																				
P08.05	DEC time 4	<table border="1"> <thead> <tr> <th>Terminal 1 (21)</th> <th>Terminal 2 (22)</th> <th>ACC/DEC time setting</th> <th>Parameters</th> </tr> </thead> <tbody> <tr> <td>OFF</td> <td>OFF</td> <td>ACC/DEC time 1</td> <td>P00.11/ P00.12</td> </tr> <tr> <td>ON</td> <td>OFF</td> <td>ACC/DEC time 2</td> <td>P08.00/ P08.01</td> </tr> <tr> <td>OFF</td> <td>ON</td> <td>ACC/DEC time 3</td> <td>P08.02/ P08.03</td> </tr> <tr> <td>ON</td> <td>ON</td> <td>ACC/DEC time 4</td> <td>P08.04/ P08.05</td> </tr> </tbody> </table>	Terminal 1 (21)	Terminal 2 (22)	ACC/DEC time setting	Parameters	OFF	OFF	ACC/DEC time 1	P00.11/ P00.12	ON	OFF	ACC/DEC time 2	P08.00/ P08.01	OFF	ON	ACC/DEC time 3	P08.02/ P08.03	ON	ON	ACC/DEC time 4	P08.04/ P08.05	<p>Refer to P00.11 and P00.12 for detailed definition.</p> <p>The first group of ACC/DEC time is the factory default one.</p> <p>Setting range: 0.0–3600.0s</p>	<input type="radio"/>
		Terminal 1 (21)	Terminal 2 (22)	ACC/DEC time setting	Parameters																			
		OFF	OFF	ACC/DEC time 1	P00.11/ P00.12																			
		ON	OFF	ACC/DEC time 2	P08.00/ P08.01																			
		OFF	ON	ACC/DEC time 3	P08.02/ P08.03																			
ON	ON	ACC/DEC time 4	P08.04/ P08.05																					
P08.06	Jog running frequency	This parameter is used to define the reference frequency during jogging. Setting range: 0.00Hz–P00.03 (the max. frequency)	5.00Hz	<input type="radio"/>																				
P08.07	Jogging running acceleration time	The jogging acceleration time means the time needed if the VFD runs from 0Hz to the max. frequency.	Depend on model	<input type="radio"/>																				
P08.08	Jogging running deceleration time	The jogging deceleration time means the time needed if the VFD goes from the max. frequency (P00.03) to 0Hz. Setting range: 0.0–3600.0s		<input type="radio"/>																				
P08.09	Jumping frequency 1	When the set frequency is in the range of jumping frequency, the VFD will run at the edge of the jumping frequency.	0.00Hz	<input type="radio"/>																				
P08.10	Jumping frequency range 1	The VFD can avoid the mechanical resonance point by setting the jumping frequency. The VFD can set three jumping frequency. But this function will be invalid if all jumping points are 0.	0.00Hz	<input type="radio"/>																				
P08.11	Jumping frequency 2		0.00Hz	<input type="radio"/>																				

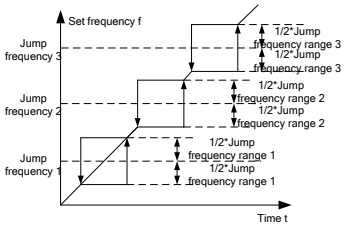
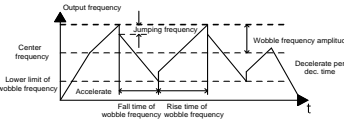
Function code	Name	Description	Default	Modify
P08.12	Jumping frequency range 2	 <p>Setting range: 0.00–P00.03 (the max. frequency)</p>	0.00Hz	<input type="radio"/>
P08.13	Jumping frequency 3		0.00Hz	<input type="radio"/>
P08.14	Jumping frequency range 3		0.00Hz	<input type="radio"/>
P08.15	Traverse range		This function applies to the industries where traverse and convolution function are required such as textile and chemical fiber.	0.0%
P08.16	Sudden jumping frequency range	The traverse function means that the output frequency of the VFD is fluctuated with the set frequency as its center. The route of the running frequency is illustrated as below, of which the traverse is set by P08.15 and when P08.15 is set as 0, the traverse is 0 with no function.	0.0%	<input type="radio"/>
P08.17	Traverse boost time		5.0s	<input type="radio"/>
P08.18	Traverse declining time	 <p>Traverse range: The traverse running is limited by upper and low frequency. The traverse range relative to the center frequency: $\text{traverse range AW} = \text{center frequency} \times \text{traverse range P08.15}$. Sudden jumping frequency = $\text{traverse range AW} \times \text{sudden jumping frequency range P08.16}$. When run at the traverse frequency, the value which is relative to the sudden jumping frequency. The raising time of the traverse frequency: The time from the lowest point to the highest one. The declining time of the traverse frequency: The time from the highest point to the lowest one.</p>	5.0s	<input type="radio"/>

Function code	Name	Description	Default	Modify
		Setting range of P08.15: 0.0–100.0% (relative to the set frequency) Setting range of P08.16: 0.0–50.0% (relative to the traverse range) Setting range of P08.17: 0.1–3600.0s Setting range of P08.18: 0.1–3600.0s		
P08.19	Linear speed/ frequency decimals	0x00–0x13 Ones place: decimals of linear speed display 0: no decimals 1: one decimal 2.: two decimals 3: three decimals Tens place: decimals of frequency display 0: two decimals 1: one decimal	0x00	○
P08.20	Analog calibration function setting	0: Disabled 1: Enabled	1	◎
P08.21	Deceleration time for emergency stop	0.0–6553.5s 0.0 indicates coasting to stop.	0.0s	○
P08.22	Delay to enter the sleep state	0.0–3600.0s It indicates the delay to enter the sleep state, and it is valid only when ones place of P01.19 is set to 2.	2.0s	○
P08.23	Preset voltage and frequency	0: 230 V preset voltage and 50Hz preset frequency 1: 220 V preset voltage and 60Hz preset frequency 2: 400 V preset voltage and 50Hz preset frequency 3: 460 V preset voltage and 60Hz preset frequency	2	◎
P08.24	Enabling energy consumption braking stop	0: Disable 1: Enable	0	○
P08.25	Setting counting value	The counter works by the input pulse signals of the HDI terminals. When the counter achieves a fixed number, the multi-function output terminals will output the	0	○
P08.26	Reference counting value		0	○

Function code	Name	Description	Default	Modify
		<p>signal of "fixed counting number arrival" and the counter go on working; when the counter achieves a setting number, the multi-function output terminals will output the signal of "setting counting number arrival", the counter will clear all numbers and stop to recount before the next pulse.</p> <p>The setting counting value P08.26 should be no more than the setting counting value P08.25.</p> <p>The function is illustrated as below:</p> <p>Setting range of P08.25: P08.26–65535 Setting range of P08.26: 0–P08.25</p>		
P08.27	Setting running time	<p>Pre-set running time of the VFD. When the accumulative running time achieves the set time, the multi-function digital output terminals will output the signal of "running time arrival".</p> <p>Setting range: 0–65535min</p>	0m	○
P08.28	Time of fault reset	<p>The time of the fault reset: set the fault reset time by selecting this function. If the reset time exceeds this set value, the VFD will stop for the fault and wait to be repaired.</p>	0	○
P08.29	Interval time of automatic fault reset	<p>The interval time of the fault reset: The interval between the time when the fault occurs and the time when the reset action occurs.</p> <p>Setting range of P08.28: 0–10 Setting range of P08.29: 0.1–3600.0s</p>	1.0s	○
P08.30	Frequency decreasing ratio in drop control	<p>The output frequency of the VFD changes as the load. And it is mainly used to balance the power when several VFDs drive one load.</p> <p>Setting range: -50.00Hz–50.00Hz</p>	0.00Hz	○
P08.32	FDT1 electrical level detection value	<p>When the output frequency exceeds the corresponding frequency of FDT electrical level, the multi-function digital output terminals will</p>	50.00Hz z	○

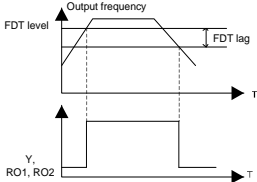
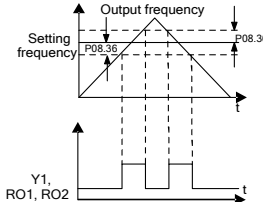
Function code	Name	Description	Default	Modify
P08.33	FDT1 retention detection value	output the signal of "frequency level detect FDT" until the output frequency decreases to a value lower than (FDT electrical level—FDT retention detection value) the corresponding frequency, the signal is invalid. Below is the waveform diagram:	5.0%	<input type="radio"/>
P08.34	FDT2 electrical level detection value		50.00Hz	<input type="radio"/>
P08.35	FDT2 retention detection value	 <p>Setting range of P08.32: 0.00Hz–P00.03 (the max. frequency) Setting range of P08.33 and P08.35: 0.0–100.0% Setting range of P08.34: 0.00Hz–P00.03 (the max. frequency)</p>	5.0%	<input type="radio"/>
P08.36	Amplitude value for frequency arrival detection	<p>When the output frequency is among the below or above range of the set frequency, the multi-function digital output terminal will output the signal of "frequency arrival", see the diagram below for detailed information:</p>  <p>Setting range: 0.00Hz–P00.03 (the max. frequency)</p>	0.00Hz	<input type="radio"/>

Function code	Name	Description	Default	Modify								
P08.37	Energy consumption brake enable	This parameter is used to control the internal braking unit. 0: Disabled 1: Enabled Note: It is only applicable to VFD models that are built in braking units.	0	<input type="radio"/>								
P08.38	Energy consumption brake threshold voltage	After setting the original bus voltage to brake the energy, adjust the voltage appropriately to brake the load. The factory changes with the voltage level. Setting range: 200.0–2000.0V In order to prevent customers set the value is too large, it is recommended setting range: <table border="1" data-bbox="322 586 796 652"> <tr> <td>Voltage</td> <td>220V/230V</td> <td>400V</td> <td>460V</td> </tr> <tr> <td>Range</td> <td>375–400V</td> <td>685–750V</td> <td>715–780V</td> </tr> </table>	Voltage	220V/230V	400V	460V	Range	375–400V	685–750V	715–780V	For 220/230V VFDs: 380.0V For 400V VFDs: 700.0V For 460V VFDs: 740.0V	<input type="radio"/>
Voltage	220V/230V	400V	460V									
Range	375–400V	685–750V	715–780V									
P08.39	Cooling fan running mode	Setting range: 0–2 0: Common running mode 1: The fan keeps running after being powered on 2: Running mode 2	0	<input type="radio"/>								
P08.40	PWM selection	0x0000–0x1121 Ones place: PWM mode selection 0: PWM mode 1, 3PH modulation and 2PH modulation 1: PWM mode 2, 3PH modulation Tens place: PWM low-speed carrier limit 0: Low-speed carrier limit mode 1 1: Low-speed carrier limit mode 2 2: No limit Hundreds place: Reserved Thousands place: PWM loading mode selection 0: Normal loading 1: Interruptive loading	0x0001	<input checked="" type="radio"/>								
P08.41	Overmodulation selection	0x00–0x11 Ones place: Whether to enable overmodulation 0: Disable overmodulation 1: Enable overmodulation	0x01	<input checked="" type="radio"/>								

Function code	Name	Description	Default	Modify
		Tens place: Overmodulation mode 0: Mild overmodulation 1: Deepened overmodulation		
P08.42	Keypad digital control setting	0x0000–0x1223 Ones place: frequency enable selection 0: Both \wedge/\vee keys and analog potentiometer adjustments are valid 1: Only \wedge/\vee keys adjustment is valid 2: Only analog potentiometer adjustments is valid 3: Neither \wedge/\vee keys nor digital potentiometer adjustments are valid Tens place: frequency control selection 0: Valid only when P00.06=0 or P00.07=0 1: Valid for all frequency setting modes 2: Invalid for multi-step speed when multi-step speed has the priority Hundreds place: action selection during stopping 0: Setting is valid 1: Valid during running, cleared after stopping 2: Valid during running, cleared after receiving the stop command Thousands place: \wedge/\vee keys and analog potentiometer integral function 0: The Integral function is valid 1: The Integral function is invalid	0x0000	○
P08.43	Integral speed ratio of keypad potentiometer	0.01–10.00s	0.10s	○
P08.44	UP/DOWN terminal control setting	0x000–0x221 Ones place: frequency control selection 0: UP/DOWN terminals setting valid 1: UP/DOWN terminals setting invalid Tens place: frequency control selection 0: Valid only when P00.06=0 or P00.07=0 1: All frequency modes are valid 2: When the multi-step speed are priority, it is invalid to multi-step speed	0x000	○

Function code	Name	Description	Default	Modify
		<p>Hundreds place: action selection when stop</p> <p>0: Setting is valid</p> <p>1: Valid in running, clear after stop</p> <p>2: Valid in running, clear after receiving the stop commands</p>		
P08.45	UP terminal frequency increment integral speed ratio	0.01–50.00s	0.50 s	<input type="radio"/>
P08.46	DOWN terminal frequency decrement integral speed ratio	0.01–50.00s	0.50 s	<input type="radio"/>
P08.47	Action selection at power loss	<p>0x000–0x111</p> <p>Ones place: Action of the digital regulation frequency at power off.</p> <p>0: Save when power off</p> <p>1: Clear when power off</p> <p>Tens place: Action of the set Modbus frequency at power off</p> <p>0: Save when power off</p> <p>1: Clear when power off</p> <p>Hundreds place: Action of the other communication frequencies at power off</p> <p>0: Save when power off</p> <p>1: Clear when power off</p>	0x000	<input type="radio"/>
P08.48	High bit of original power consumption value	<p>This parameter is used to set the original value of the power consumption.</p> <p>The original value of the power consumption = (P08.48 × 1000 + P08.49) kWh</p> <p>Setting range of P08.48: 0–59999</p> <p>Setting range of P08.49: 0.0–999.9</p>	0	<input type="radio"/>
P08.49	Low bit of original power consumption value		0.0	<input type="radio"/>

Function code	Name	Description	Default	Modify
P08.50	Flux brake coefficient	<p>This function code is used to enable magnetic flux.</p> <p>0: Invalid.</p> <p>100–150: the bigger the coefficient, the bigger the braking strength.</p> <p>This VFD can slow down the motor by increasing the magnetic flux. The energy generated by the motor during braking can be transformed into heat energy by increasing the magnetic flux.</p> <p>The VFD monitors the state of the motor continuously even during magnetic flux period. So the magnetic flux can be used in the motor stop, as well as to change the rotation speed of the motor. Its other advantages are:</p> <p>Brake immediately after the stop command. It does not need to wait the magnetic flux weaken.</p> <p>The cooling is better. The current of the stator other than the rotor increases during magnetic flux braking, while the cooling of the stator is more effective than the rotor.</p>	0	<input type="radio"/>
P08.51	VFD input power factor	<p>This function code is used to adjust the displayed current of the AC input side.</p> <p>Setting range: 0.00–1.00</p>	0.56	<input type="radio"/>

P09 group PID control

Function code	Name	Description	Default	Modify
P09.00	PID reference source	<p>When the frequency command selection (P00.06, P00.07) is 7 or the voltage setting channel selection (P04.27) is 6, the running mode of the VFD is process PID control.</p> <p>The parameter determines the target reference channel during the PID process.</p> <p>0: P09.01</p> <p>1: AI1</p> <p>2: AI2</p> <p>3: AI3</p> <p>4: High speed pulse HDI</p> <p>5: Multi-step running</p>	0	<input type="radio"/>

Function code	Name	Description	Default	Modify
		6: Modbus communication 7-9: Reserved The set target of process PID is a relative value, for which 100% equals 100% of the feedback signal of the controlled system. The system always performs calculation by using a relative value (0-100.0%). Note: Multi-step running can be realized by setting P10 group parameters.		
P09.01	PID value reference	The function code is mandatory when P09.00=0. The basic value of the function code is the feedback of the system. Setting range:-100.0%-100.0%	0.0%	<input type="radio"/>
P09.02	PID feedback source	Select the PID channel by the parameter. 0: AI1 1: AI2 2: AI3 3: High speed HDI 4: Modbus communication 5: Max (AI2 , AI3) 6-7: Reserved Note: The reference channel and the feedback channel cannot coincide; otherwise, PID cannot control effectively.	0	<input type="radio"/>
P09.03	PID output feature	0: PID output is positive: when the feedback signal exceeds the PID reference value, the output frequency of the VFD will decrease to balance the PID. For example, the strain PID control during wrap-up 1: PID output is negative: When the feedback signal is stronger than the PID reference value, the output frequency of the VFD will increase to balance the PID. For example, the strain PID control during wrap down.	0	<input type="radio"/>
P09.04	High frequency proportional gain (Kp)	The function is applied to the proportional gain P of PID input. P determines the strength of the whole PID adjuster. The parameter of 100 means that when	1.00	<input type="radio"/>

Function code	Name	Description	Default	Modify
		the offset of PID feedback and reference value is 100%, the adjusting range of PID adjustor is the max. frequency (ignoring integral function and differential function). Setting range: 0.00–100.00		
P09.05	High frequency integral time (Ti)	This parameter determines the speed of PID adjustor to carry out integral adjustment on the deviation of PID feedback and reference. When the deviation of PID feedback and reference is 100%, the integral adjustor works continuously after the time (ignoring the proportional effect and differential effect) to achieve the max. frequency (P00.03) or the max. voltage (P04.31). Shorter the integral time, stronger is the adjustment Setting range: 0.00–10.00s	0.10s	○
P09.06	High frequency differential time (Td)	This parameter determines the strength of the change ratio when PID adjustor carries out integral adjustment on the deviation of PID feedback and reference. If the PID feedback changes 100% during the time, the adjustment of integral adjustor (ignoring the proportional effect and differential effect) is the max. frequency (P00.03) or the max. voltage (P04.31). Longer the integral time, stronger is the adjusting. Setting range: 0.00–10.00s	0.00s	○
P09.07	Sampling cycle (T)	This parameter means the sampling cycle of the feedback. The modulator calculates in each sampling cycle. The longer the sapling cycle is, the slower the response is. Setting range: 0.001–10.000s	0.100s	○
P09.08	PID control deviation limit	The output of PID system is relative to the maximum deviation of the close loop reference. As shown in the diagram below, PID adjustor stops to work during the deviation limit. Set the function properly to adjust the accuracy and stability of the system.	0.0%	○

Function code	Name	Description	Default	Modify
		<p>Setting range: 0.0–100.0%</p>		
P09.09	Upper limit of PID output	These parameters are used to set the upper and lower limit of the PID adjustor output. 100.0 % corresponds to max. frequency or the max. voltage of (P04.31) Setting range of P09.09: P09.10–100.0% Setting range of P09.10: -100.0%–P09.09	100.0%	<input type="radio"/>
P09.10	Lower limit of PID output		0.0%	<input type="radio"/>
P09.11	Feedback offline detection value	Set the PID feedback offline detection value, when the detection value is smaller than or equal to the feedback offline detection value, and the lasting time exceeds the set value in P09.12, the VFD will report "PID feedback offline fault" and the keypad will display PIDE.	0.0%	<input type="radio"/>
P09.12	Feedback offline detection time		<p>Setting range of P09.11: 0.0–100.0% Setting range of P09.12: 0.0–3600.0s</p>	1.0s
P09.13	PID adjustment selection	0x0000–0x1111 Ones place: 0: Continue integral control after the frequency reaches upper/lower limit 1: Stop integral control after the frequency reaches upper/lower limit Tens place: 0: The same with the main reference direction	0x0001	<input type="radio"/>

Function code	Name	Description	Default	Modify
		1: Opposite to the main reference direction Hundreds place: 0: Limit based on the max. frequency 1: Limit based on A frequency Thousands place: 0: A+B frequency, ACC/DEC of main reference A frequency source buffering is invalid 1: A+B frequency, ACC/DEC of main reference A frequency source buffering is valid, ACC and DEC are determined by P08.04 .		
P09.15	PID command acceleration/ deceleration time	0.0–1000.0s	0.0s	<input type="radio"/>
P09.16	PID output filter time	0.000–10.000s	0.000s	<input type="radio"/>
P09.17	Low frequency proportional gain (Kp)	0.00–100.00	1.00	<input type="radio"/>
P09.18	Low frequency integral time (Ti)	0.00–10.00s	0.10s	<input type="radio"/>
P09.19	Low frequency differential time (Td)	0.00–10.00s	0.00s	<input type="radio"/>
P09.20	Low point frequency of PID parameter switching	0.00Hz–P09.21 When the ramp frequency is no greater than P09.20, current PID parameters are P09.17–P09.19. When the ramp frequency is no less than P09.21, current PID parameters are P09.04–P09.06. The medium frequency range is the linear interpolation values between the two PID parameter groups.	5.00Hz	<input type="radio"/>
P09.21	High point frequency of PID parameter switching	P09.20–P00.03	10.00Hz	<input type="radio"/>

P10 group Simple PLC and multi-step speed control

Function code	Name	Description	Default	Modify	
P10.00	Simple PLC mode	0: Stop after running once; the VFD stops automatically after running for one cycle, and it can be started only after receiving running command. 1: Keep running in the final value after running once. The VFD keeps the running frequency and direction of the last section after a single cycle. 2: Cyclic running; the VFD enters the next cycle after completing one cycle until receiving stop command and stops.	0	○	
P10.01	Simple PLC memory selection	0: No memory after power-off 1: Memory after power-off; PLC memories its running step and frequency before power-off.	0	○	
P10.02	Multi-step speed 0	<p>100.0% of the frequency setting corresponds to the max. frequency P00.03.</p> <p>When selecting simple PLC running, set P10.02–P10.33 to define the running frequency and direction of all stages.</p> <p>Note: The symbol of multi-step determines the running direction of simple PLC. The negative value means reverse rotation.</p>	0.0%	○	
P10.03	Running time of step 0		0.0s	○	
P10.04	Multi-step speed 1		0.0%	○	
P10.05	Running time of step 1		0.0s	○	
P10.06	Multi-step speed 2		0.0%	○	
P10.07	Running time of step 2		0.0s	○	
P10.08	Multi-step speed 3		0.0%	○	
P10.09	Running time of step 3		0.0s	○	
P10.10	Multi-step speed 4		Multi-step speeds are in the range of $--f_{\max}$ – f_{\max} and it can be set continuously.	0.0%	○
P10.11	Running time of step 4		Goodrive20-EU series VFDs can set 16 stages speed, selected by the combination of multi-step terminals 1–4, corresponding to the speed 0 to speed 15.	0.0s	○
P10.12	Multi-step speed 5		0.0%	○	
P10.13	Running time of step 5		0.0s	○	

Function code	Name	Description	Default	Modify																																																																																	
P10.14	Multi-step speed 6	<p>When terminal1= terminal 2= terminal 3= terminal 4=OFF, the frequency input manner is selected via code P00.06 or P00.07. When all terminals aren't off, it runs at multi-step which takes precedence of keypad, analog value, high-speed pulse, PLC, communication frequency input. Select at most 16 steps speed via the combination code of terminal 1, terminal 2, terminal 3, and terminal 4.</p> <p>The start-up and stopping of multi-step running is determined by function code P00.06, the relationship between terminal 1 (16) terminal 2 (17), terminal 3 (18), terminal 4 (19) and multi-step speed is as following:</p> <table border="1"> <thead> <tr> <th>Terminal 1</th> <th>OFF</th> <th>ON</th> <th>OFF</th> <th>ON</th> <th>OFF</th> <th>ON</th> <th>OFF</th> <th>ON</th> </tr> </thead> <tbody> <tr> <td>Terminal 2</td> <td>OFF</td> <td>OFF</td> <td>ON</td> <td>ON</td> <td>OFF</td> <td>OFF</td> <td>ON</td> <td>ON</td> </tr> <tr> <td>Terminal 3</td> <td>OFF</td> <td>OFF</td> <td>OFF</td> <td>OFF</td> <td>ON</td> <td>ON</td> <td>ON</td> <td>ON</td> </tr> <tr> <td>Terminal 4</td> <td>OFF</td> <td>OFF</td> <td>OFF</td> <td>OFF</td> <td>OFF</td> <td>OFF</td> <td>OFF</td> <td>OFF</td> </tr> <tr> <th>step</th> <th>0</th> <th>1</th> <th>2</th> <th>3</th> <th>4</th> <th>5</th> <th>6</th> <th>7</th> </tr> <tr> <td>Terminal 1</td> <td>OFF</td> <td>ON</td> <td>OFF</td> <td>ON</td> <td>OFF</td> <td>ON</td> <td>OFF</td> <td>ON</td> </tr> <tr> <td>Terminal 2</td> <td>OFF</td> <td>OFF</td> <td>ON</td> <td>ON</td> <td>OFF</td> <td>OFF</td> <td>ON</td> <td>ON</td> </tr> <tr> <td>Terminal 3</td> <td>OFF</td> <td>OFF</td> <td>OFF</td> <td>OFF</td> <td>ON</td> <td>ON</td> <td>ON</td> <td>ON</td> </tr> <tr> <td>Terminal 4</td> <td>ON</td> <td>ON</td> <td>ON</td> <td>ON</td> <td>ON</td> <td>ON</td> <td>ON</td> <td>ON</td> </tr> </tbody> </table>	Terminal 1	OFF	ON	OFF	ON	OFF	ON	OFF	ON	Terminal 2	OFF	OFF	ON	ON	OFF	OFF	ON	ON	Terminal 3	OFF	OFF	OFF	OFF	ON	ON	ON	ON	Terminal 4	OFF	OFF	OFF	OFF	OFF	OFF	OFF	OFF	step	0	1	2	3	4	5	6	7	Terminal 1	OFF	ON	OFF	ON	OFF	ON	OFF	ON	Terminal 2	OFF	OFF	ON	ON	OFF	OFF	ON	ON	Terminal 3	OFF	OFF	OFF	OFF	ON	ON	ON	ON	Terminal 4	ON	ON	ON	ON	ON	ON	ON	ON	0.0%	<input type="radio"/>
Terminal 1	OFF		ON	OFF	ON	OFF	ON	OFF	ON																																																																												
Terminal 2	OFF		OFF	ON	ON	OFF	OFF	ON	ON																																																																												
Terminal 3	OFF		OFF	OFF	OFF	ON	ON	ON	ON																																																																												
Terminal 4	OFF		OFF	OFF	OFF	OFF	OFF	OFF	OFF																																																																												
step	0		1	2	3	4	5	6	7																																																																												
Terminal 1	OFF		ON	OFF	ON	OFF	ON	OFF	ON																																																																												
Terminal 2	OFF		OFF	ON	ON	OFF	OFF	ON	ON																																																																												
Terminal 3	OFF		OFF	OFF	OFF	ON	ON	ON	ON																																																																												
Terminal 4	ON		ON	ON	ON	ON	ON	ON	ON																																																																												
P10.15	Running time of step 6		0.0s	<input type="radio"/>																																																																																	
P10.16	Multi-step speed 7		0.0%	<input type="radio"/>																																																																																	
P10.17	Running time of step 7		0.0s	<input type="radio"/>																																																																																	
P10.18	Multi-step speed 8		0.0%	<input type="radio"/>																																																																																	
P10.19	Running time of step 8		0.0s	<input type="radio"/>																																																																																	
P10.20	Multi-step speed 9	0.0%	<input type="radio"/>																																																																																		
P10.21	Running time of step 9	0.0s	<input type="radio"/>																																																																																		
P10.22	Multi-step speed 10	0.0%	<input type="radio"/>																																																																																		
P10.23	Running time of step 10	0.0s	<input type="radio"/>																																																																																		
P10.24	Multi-step speed 11	0.0%	<input type="radio"/>																																																																																		
P10.25	Running time of step 11	0.0s	<input type="radio"/>																																																																																		
P10.26	Multi-step speed 12	0.0%	<input type="radio"/>																																																																																		
P10.27	Running time of step 12	0.0s	<input type="radio"/>																																																																																		
P10.28	Multi-step speed 13	0.0%	<input type="radio"/>																																																																																		
P10.29	Running time of step 13	0.0s	<input type="radio"/>																																																																																		
P10.30	Multi-step speed 14	0.0%	<input type="radio"/>																																																																																		
P10.31	Running time of step 14	0.0s	<input type="radio"/>																																																																																		
P10.32	Multi-step speed 15	Setting range of P10.(2n, 1<n<17): -100.0~100.0%	0.0%	<input type="radio"/>																																																																																	

Function code	Name	Description	Default	Modify																																																																																																									
P10.33	Running time of step 15	Setting range of P10.(2n+1, 1<n<17): 0.0–6553.5s (min)	0.0s	○																																																																																																									
P10.34	Acceleration/ deceleration time selection of simple PLC 0–7 step	<p>Below is the detailed instruction:</p> <table border="1"> <thead> <tr> <th>Function code</th> <th>Binary bit</th> <th>Step</th> <th>ACC/ DEC 0</th> <th>ACC/ DEC 1</th> <th>ACC/ DEC 2</th> <th>ACC/ DEC 3</th> </tr> </thead> <tbody> <tr> <td rowspan="7">P10.34</td> <td>BIT1 BIT0</td> <td>0</td> <td>00</td> <td>01</td> <td>10</td> <td>11</td> </tr> <tr> <td>BIT3 BIT2</td> <td>1</td> <td>00</td> <td>01</td> <td>10</td> <td>11</td> </tr> <tr> <td>BIT5 BIT4</td> <td>2</td> <td>00</td> <td>01</td> <td>10</td> <td>11</td> </tr> <tr> <td>BIT7 BIT6</td> <td>3</td> <td>00</td> <td>01</td> <td>10</td> <td>11</td> </tr> <tr> <td>BIT9 BIT8</td> <td>4</td> <td>00</td> <td>01</td> <td>10</td> <td>11</td> </tr> <tr> <td>BIT11 BIT10</td> <td>5</td> <td>00</td> <td>01</td> <td>10</td> <td>11</td> </tr> <tr> <td>BIT13 BIT12</td> <td>6</td> <td>00</td> <td>01</td> <td>10</td> <td>11</td> </tr> <tr> <td>BIT15 BIT14</td> <td>7</td> <td>00</td> <td>01</td> <td>10</td> <td>11</td> </tr> <tr> <td rowspan="7">P10.35</td> <td>BIT1 BIT0</td> <td>8</td> <td>00</td> <td>01</td> <td>10</td> <td>11</td> </tr> <tr> <td>BIT3 BIT2</td> <td>9</td> <td>00</td> <td>01</td> <td>10</td> <td>11</td> </tr> <tr> <td>BIT5 BIT4</td> <td>10</td> <td>00</td> <td>01</td> <td>10</td> <td>11</td> </tr> <tr> <td>BIT7 BIT6</td> <td>11</td> <td>00</td> <td>01</td> <td>10</td> <td>11</td> </tr> <tr> <td>BIT9 BIT8</td> <td>12</td> <td>00</td> <td>01</td> <td>10</td> <td>11</td> </tr> <tr> <td>BIT11 BIT10</td> <td>13</td> <td>00</td> <td>01</td> <td>10</td> <td>11</td> </tr> <tr> <td>BIT13 BIT12</td> <td>14</td> <td>00</td> <td>01</td> <td>10</td> <td>11</td> </tr> <tr> <td>BIT15 BIT14</td> <td>15</td> <td>00</td> <td>01</td> <td>10</td> <td>11</td> </tr> </tbody> </table>	Function code	Binary bit	Step	ACC/ DEC 0	ACC/ DEC 1	ACC/ DEC 2	ACC/ DEC 3	P10.34	BIT1 BIT0	0	00	01	10	11	BIT3 BIT2	1	00	01	10	11	BIT5 BIT4	2	00	01	10	11	BIT7 BIT6	3	00	01	10	11	BIT9 BIT8	4	00	01	10	11	BIT11 BIT10	5	00	01	10	11	BIT13 BIT12	6	00	01	10	11	BIT15 BIT14	7	00	01	10	11	P10.35	BIT1 BIT0	8	00	01	10	11	BIT3 BIT2	9	00	01	10	11	BIT5 BIT4	10	00	01	10	11	BIT7 BIT6	11	00	01	10	11	BIT9 BIT8	12	00	01	10	11	BIT11 BIT10	13	00	01	10	11	BIT13 BIT12	14	00	01	10	11	BIT15 BIT14	15	00	01	10	11	0x0000	○
Function code	Binary bit	Step	ACC/ DEC 0	ACC/ DEC 1	ACC/ DEC 2	ACC/ DEC 3																																																																																																							
P10.34	BIT1 BIT0	0	00	01	10	11																																																																																																							
	BIT3 BIT2	1	00	01	10	11																																																																																																							
	BIT5 BIT4	2	00	01	10	11																																																																																																							
	BIT7 BIT6	3	00	01	10	11																																																																																																							
	BIT9 BIT8	4	00	01	10	11																																																																																																							
	BIT11 BIT10	5	00	01	10	11																																																																																																							
	BIT13 BIT12	6	00	01	10	11																																																																																																							
BIT15 BIT14	7	00	01	10	11																																																																																																								
P10.35	BIT1 BIT0	8	00	01	10	11																																																																																																							
	BIT3 BIT2	9	00	01	10	11																																																																																																							
	BIT5 BIT4	10	00	01	10	11																																																																																																							
	BIT7 BIT6	11	00	01	10	11																																																																																																							
	BIT9 BIT8	12	00	01	10	11																																																																																																							
	BIT11 BIT10	13	00	01	10	11																																																																																																							
	BIT13 BIT12	14	00	01	10	11																																																																																																							
BIT15 BIT14	15	00	01	10	11																																																																																																								
P10.35	Acceleration/ deceleration time selection of simple PLC 8–15 step	<p>After the users select the corresponding ACC/DEC time, the combining 16 binary bit will change into decimal bit, and then set the corresponding function codes. Setting range: -0x0000–0xFFFF</p>	0x0000	○																																																																																																									
P10.36	PLC restart mode	<p>0: Restart from the first stage; stop during running (caused by the stop command, fault or power loss), run from the first stage after restart. 1: Continue to run from the stop frequency; stop during running (cause by stop command and fault), the VFD will record the running time automatically, enter into the stage after restart and keep the remaining running at the setting frequency.</p>	0	◎																																																																																																									
P10.37	Multi-step time unit selection	0: Seconds; the running time of all stages is counted by second	0	◎																																																																																																									

Function code	Name	Description	Default	Modify
		1: Minutes; the running time of all stages is counted by minute		

P11 group Protection parameters

Function code	Name	Description	Default	Modify										
P11.00	Phase loss protection	0x000–0x111 Ones place: 0: Input phase loss software protection disable 1: Input phase loss software protection enable Tens place: 0: Output phase loss protection disable 1: Output phase loss protection enable Hundreds place: 0: Input phase loss hardware protection disable 1: Input phase loss hardware protection enable	0x010	<input type="radio"/>										
P11.01	Frequency-drop at sudden power dip	0: Disable 1: Enable	0	<input type="radio"/>										
P11.02	Frequency-drop ratio at sudden power dip	Setting range: 0.00Hz/s–P00.03 (the max. frequency) After the power loss of the grid, the bus voltage drops to the sudden frequency-decreasing point, the VFD begin to decrease the running frequency at P11.02, to make the VFD generate power again. The returning power can maintain the bus voltage to ensure a rated running of the VFD until the recovery of power. <table border="1" data-bbox="326 1055 799 1278"> <tbody> <tr> <td>Voltage degree</td> <td>220/ 230V</td> <td>400V</td> <td>460V</td> <td>660V</td> </tr> <tr> <td>Frequency decrease point at sudden power loss</td> <td>240V</td> <td>460V</td> <td>530V</td> <td>800V</td> </tr> </tbody> </table> <p>Note: ✧ Adjust the parameter properly to avoid the stopping caused by VFD protection during the</p>	Voltage degree	220/ 230V	400V	460V	660V	Frequency decrease point at sudden power loss	240V	460V	530V	800V	10.00 Hz/s	<input type="radio"/>
Voltage degree	220/ 230V	400V	460V	660V										
Frequency decrease point at sudden power loss	240V	460V	530V	800V										

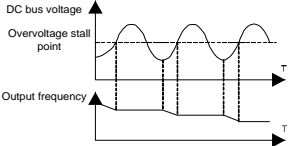
Function code	Name	Description	Default	Modify
		switching of the grid. ◇ Prohibit the input phase loss protection to enable this function.		
P11.03	Overvoltage stall protection	0: Disabled 1: Enabled 	1	○
P11.04	Overvoltage stall protective voltage	110–150% (standard bus voltage) (400V)	130%	○
		110–150% (standard bus voltage) (220/230/460V)	120%	
P11.05	Current limit action	During the accelerating operation of the VFD, due to the large load, actual rising rate of the motor rotating speed is lower than rising rate of the output frequency. Measures shall be taken to avoid VFD tripping caused by overcurrent during acceleration. 0x00–0x11 Ones place: Current limit action setting 0: Invalid 1: Always valid Tens place: Hardware current limit overload alarm setting 0: Valid 1: Invalid	0x01	◎
P11.06	Automatic current limit level	Current limit protection function detects output current during running, and compares it with the current-limit level defined by P11.06, if it exceeds the current-limit level, the VFD will run at stable frequency during accelerated running, or run in decreased frequency during constant-speed running; if it exceeds the current-limit level continuously, the VFD output frequency will drop	160.0%	◎
P11.07	Frequency-drop rate during current limit		10.00 Hz/s	◎

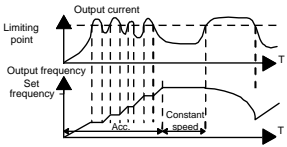
Function code	Name	Description	Default	Modify
		<p>continuously until reaching lower limit frequency. When the output current is detected to be lower than the current-limit level again, it will continue accelerated running.</p>  <p>Setting range of P11.06: 50.0–200.0% (relative to the percentage of rated current of the VFD) Setting range of P11.07: 0.00–50.00Hz/s</p>		
P11.08	Pre-alarm selection for VFD/motor OL/UL	<p>0x0000–0x1131 Ones place: 0: Motor overload/underload pre-alarm, relative to rated motor current; 1: VFD overload/underload pre-alarm, relative to rated VFD current. 2: Motor output torque overload/underload pre-alarm, relative to rated motor torque Tens place: 0: The VFD continues running after overload/underload alarm; 1: The VFD continues running after underload alarm, and stops running after overload fault; 2: The VFD continues running after overload alarm, and stops running after underload fault; 3: The VFD stops running after overload/underload fault. Hundreds place: 0: Always detect 1: Detect during constant-speed running Thousands place: Overload integral function selection 0: Overload integral is invalid; 1: Overload integral is valid.</p>	0x0000	○

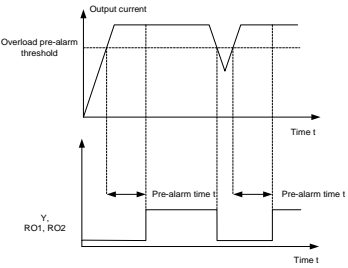
Function code	Name	Description	Default	Modify
P11.09	Overload pre-alarm detection level	Overload pre-alarm signal will be outputted if the output current of the VFD or motor is higher than overload pre-alarm detection level (P11.09), and the duration exceeds overload pre-alarm detection time (P11.10).	150%	<input type="radio"/>
P11.10	Overload pre-alarm detection time	 <p>Setting range of P11.09: P11.11–200% (relative value determined by ones place of P11.08) Setting range of P11.10: 0.1–3600.0s</p>	1.0s	<input type="radio"/>
P11.11	Underload pre-alarm detection level	If the VFD current or the output current is lower than P11.11, and its lasting time is beyond P11.12, the VFD will output underload pre-alarm.	50%	<input type="radio"/>
P11.12	Underload pre-alarm detection time	Setting range of P11.11: 0–P11.09 (relative value determined by ones place of P11.08) Setting range of P11.12: 0.1–3600.0s	1.0s	<input type="radio"/>
P11.13	Output terminal action selection during fault	Select the action of fault output terminals on undervoltage and fault reset. 0x00–0x11 Ones place: 0: Action during undervoltage fault 1: No action during undervoltage fault Tens place: 0: Action during the automatic reset period 1: No action during the automatic reset period	0x00	<input type="radio"/>
P11.16	Extension function selection	0x000–0x111 Ones place: Automatic frequency-drop at voltage drop	0x000	<input type="radio"/>

Function code	Name	Description	Default	Modify
		0: Disable 1: Enable Tens place: The second ACC/DEC time selection 0: Disable 1: Enable When the operation is above P08.36, ACC/DEC time is switched to the second ACC/DEC time Hundreds place: STO function selection 0: STO alarm locked Alarm locked means when STO appears, reset is a must after state recovery. 1: STO alarm unlocked STO alarm unlocked means when STO appears, STO alarm will disappeared automatically after state recovery. Note: STL1–STL3 are fault lock and cannot be reset.		

P13 group SM control

Function code	Name	Description	Default	Modify
P13.09	Frequency threshold of phase-lock loop switch-in	0.00–400.00	2.00	<input type="radio"/>
P13.13	Short circuit brake current	After the VFD starts, when P01.00=0, set P13.14 to non-zero value and begin short circuit braking.	0.0%	<input type="radio"/>
P13.14	Hold time of short circuit brake at start	After the VFD stops, when the operation frequency is less than P01.09, set P13.15 to non-zero value and begin stopping short-circuit braking and then DC braking.	0.00s	<input type="radio"/>
P13.15	Hold time of short circuit brake at stop	Setting range of P13.13: 0.0–150.0% (relative to the percentage of rated current of the VFDs) Setting range of P13.14: 0.00–50.00s	0.00s	<input type="radio"/>

P14 group Serial communication

Function code	Name	Description	Default	Modify
P14.00	local communication address	<p>Setting range: 1–247</p> <p>When the master is writing the frame, the communication address of the slave is set to 0; the broadcast address is the communication address. All slaves on the Modbus fieldbus can receive the frame, but the slave doesn't answer. The communication address of the drive is unique in the communication net. This is the fundamental for the point to point communication between the upper monitor and the drive.</p> <p>Note: The address of the slave cannot set to 0.</p>	1	<input type="radio"/>
P14.01	Communication baud rate setup	<p>Set the digital transmission speed between the upper monitor and the VFD.</p> <p>0: 1200BPS 1: 2400BPS 2: 4800BPS 3: 9600BPS 4: 19200BPS 5: 38400BPS 6: 57600BPS</p> <p>Note: The baud rate between the upper monitor and the VFD must be the same. Otherwise, the communication is not applied. The bigger the baud rate, the quicker the communication speed.</p>	4	<input type="radio"/>
P14.02	Data bit check setup	<p>The data format between the upper monitor and the VFD must be the same. Otherwise, the communication is not applied.</p> <p>0: No parity check (N, 8, 1) for RTU 1: Even parity check (E, 8, 1) for RTU 2: Odd parity check (O, 8, 1) for RTU 3: No check (N, 8, 2) for RTU 4: Even parity check (E, 8, 2) for RTU 5: Odd parity check (O, 8, 2) for RTU 6: No check (N, 7, 1) for ASCII 7: Even check (E, 7, 1) for ASCII 8: Odd check (O, 7, 1) for ASCII 9: No check (N, 7, 2) for ASCII 10: Even check (E, 7, 2) for ASCII</p>	1	<input type="radio"/>

Function code	Name	Description	Default	Modify
		11: Odd check (O, 7, 2) for ASCII 12: No check (N, 8, 1) for ASCII 13: Even check (E, 8, 1) for ASCII 14: Odd check (O, 8, 1) for ASCII 15: No check (N, 8, 2) for ASCII 16: Even check (E, 8, 2) for ASCII 17: Odd check (O, 8, 2) for ASCII		
P14.03	Communication response delay	0–200ms It means the interval time between the drive receive the data and sent it to the upper monitor. If the answer delay is shorter than the system processing time, then the answer delay time is the system processing time, if the answer delay is longer than the system processing time, then after the system deal with the data, waits until achieving the answer delay time to send the data to the upper monitor.	5	<input type="radio"/>
P14.04	RS485 communication overtime fault time	0.0 (invalid)–60.0s When the function code is set as 0.0, the communication overtime parameter is invalid. When the function code is set as non-zero, if the interval time between two communications exceeds the communication overtime, the system will report "485 communication faults" (CE).	0.0s	<input type="radio"/>
P14.05	Transmission error processing	0: Alarm and stop freely 1: No alarm and continue running 2: No alarm and stop as per the stop mode (only under communication control mode) 3: No alarm and stop as per the stop mode (under all control modes)	0	<input type="radio"/>
P14.06	Communication processing action selection	0x000–0x111 Ones place: Responding to write operations 0: Yes 1: No Tens place: Communication encryption 0: Disabled 1: Enabled	0x000	<input type="radio"/>

Function code	Name	Description	Default	Modify
		Hundreds place: User-defined communication command address 0: Disabled 1: Enabled		
P14.07	User-defined address for running commands	0x0000–0xffff	0x1000	○
P14.08	User-defined address for frequency setting	0x0000–0xffff	0x2000	○

P17 group Status viewing

Function code	Name	Description	Default	Modify
P17.00	Setting frequency	Display current set frequency of the VFD Range: 0.00Hz–P00.03	0.00Hz	●
P17.01	Output frequency	Display current output frequency of the VFD Range: 0.00Hz–P00.03	0.00Hz	●
P17.02	Ramp reference frequency	Display current ramp reference frequency of the VFD Range: 0.00Hz–P00.03	0.00Hz	●
P17.03	Output voltage	Display current output voltage of the VFD Range: 0–1200V	0V	●
P17.04	Output current	Display current output current of the VFD Range: 0.0–5000.0A	0.0A	●
P17.05	Motor speed	Display the rotation speed of the motor. Range: 0–65535RPM	0 RPM	●
P17.06	Torque current	Display current torque current of the VFD Range: 0.0–5000.0A	0.0A	●
P17.07	Magnetized current	Display current magnetized current of the VFD Range: 0.0–5000.0A	0.0A	●
P17.08	Motor power	Display current power of the motor. Setting range: -300.0%–300.0% (the rated current of the motor)	0.0A	●
P17.09	Output torque	Display the current output torque of the VFD. Range: -250.0–250.0%	0.0%	●

Function code	Name	Description	Default	Modify
P17.10	Motor frequency evaluation	Evaluate the motor rotor frequency on open loop vector Range: 0.00–P00.03	0.00Hz	●
P17.11	DC bus voltage	Display current DC bus voltage of the VFD Range: 0.0–2000.0V	0.0V	●
P17.12	Switch input terminals state	Display current Switch input terminals state of the VFD Range: 0x0000–0x00FF	0x0000	●
P17.13	Switch output terminals state	Display current Switch output terminals state of the VFD Range: 0x0000–0x000F	0x0000	●
P17.14	Digital adjustment	Display the adjustment through the keypad of the VFD. Range : 0.00Hz–P00.03	0.00Hz	●
P17.15	Torque reference	Display the torque reference, the percentage to the current rated torque of the motor. Setting range: -300.0%–300.0% (of the rated motor current)	0.0%	●
P17.16	Linear speed	Display the current linear speed of the VFD. Range: 0–65535	0	●
P17.18	Counting value	Display current counting number of the VFD. Range: 0–65535	0	●
P17.19	AI1 input voltage	Display analog AI1 input signal Range: 0.00–10.00V	0.00V	●
P17.20	AI2 input voltage	Display analog AI2 input signal Range: 0.00–10.00V	0.00V	●
P17.21	AI3 input voltage	Display analog AI2 input signal Range: -10.00–10.00V	0.00V	●
P17.22	HDI input frequency	Display HDI input frequency Range: 0.000–50.000kHz	0.000k Hz	●
P17.23	PID reference value	Display PID reference value Range: -100.0–100.0%	0.0%	●
P17.24	PID feedback value	Display PID feedback value Range: -100.0–100.0%	0.0%	●
P17.25	Power factor of the motor	Display the current power factor of the motor. Range: -1.00–1.00	0.00	●
P17.26	Current running time	Display the current running time of the VFD. Range: 0–65535min	0m	●

Function code	Name	Description	Default	Modify
P17.27	Simple PLC and present stage of multi-step speed	Display simple PLC and the current stage of the multi-step speed Range: 0–15	0	●
P17.28	ASR controller output	The percentage of the rated torque of the relative motor, display ASR controller output Range: -300.0%–300.0% (rated motor current)	0.0%	●
P17.32	Magnetic flux linkage	Display the magnetic flux linkage of the motor. Range: 0.0%–200.0%	0.0%	●
P17.33	Exciting current reference	Display the exciting current reference in the vector control mode. Range: -3000.0–3000.0A	0.0A	●
P17.34	Torque current reference	Display the torque current reference in the vector control mode. Range: -3000.0–3000.0A	0.0A	●
P17.35	AC input current	Display the input current in AC side. Range: 0.0–5000.0A	0.0A	●
P17.36	Output torque	Display the output torque. Positive value is in the electromotion state, and negative value is in the power generating state. Range: -3000.0Nm–3000.0Nm	0.0Nm	●
P17.37	Motor overload counting	0–100 (Display the "OL1" fault when the count value is 100)	0	●
P17.38	PID output	Display PID output -100.0–100.0%	0.0%	●
P17.39	Parameter download error	0.00–99.99	0.00	●
P17.40	Process PID proportional gain	0.00–100.00	0.00	●
P17.41	Process PID integral time	0.00–10.00s	0.00s	●
P17.42	Process PID differential time	0.00–10.00s	0.00s	●

P18 group Functions for PTC temperature detection

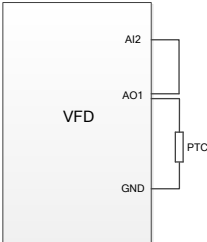
Function code	Name	Description	Default	Modify
P18.00	PTC input source selection	<p>0: No input 1: AI2 input 2: AI3 input</p> <p>Steps of using PTC function</p> <ol style="list-style-type: none"> 1. Use AO1 as the constant current source output, and jump the AO1's jumper to current output mode. 2. Set P6.14=24. 3. Set the current of constant-current source through P18.01. 4. Connect the PTC resistor to AO1 and GND terminals, and connect AO1 to AI2. 5. Inverter calculates the actual resistance of PTC by detecting the value of AI2 voltage, and puts PTC resistance to display through P18.04. 6. According to the values set by P18.02 and P18.03 for fault protection and fault reset, when the detected resistance value is higher than the setting value of P18.02, the inverter report OH3 fault. When the resistance value is lower than the setting value of P18.03, the OH3 fault can be reset. 7. When there is a deviation between the detecting resistance value and the true value, we can modify the detection resistance value by changing the setting curve of AO or AI. 8. Usually AO1 connect AI2, AO2 connect AI3. 	0	○

Function code	Name	Description	Default	Modify
P18.01	Source input current setting at constant current	0.000–20.000mA	4.000	<input type="radio"/>
P18.02	PTC resistance alarm threshold	0–60000Ω	750	<input type="radio"/>
P18.03	PTC resistance alarm recovery threshold	0–60000Ω	150	<input type="radio"/>
P18.04	Actual PTC resistance	0–60000Ω	0	<input checked="" type="radio"/>

Chapter 6 Fault tracking

6.1 Fault prevention

This chapter describes how to carry out preventive maintenance on VFDs.

6.1.1 Periodical maintenance

If the VFD is installed in an environment that meets requirements, little maintenance is needed. The following table describes the routine maintenance periods recommended by INVT. For more detailed information on maintenance, please contact us.

Item to be checked	Details	Check mode	Criterion	
Ambient environment	Check the ambient temperature, humidity and vibration and ensure there is no dust, gas, oil fog and water drop.	Visual examination and instrument test	Conforming to the manual.	
	Ensure there are no tools or other foreign or dangerous objects	Visual examination	There are no tools or dangerous objects.	
Voltage	Ensure the main circuit and control circuit are normal.	Measurement by multimeter	Conforming to the manual.	
Keypad	Ensure the display is clear enough	Visual examination	The characters are displayed normally.	
	Ensure the characters are displayed totally	Visual examination	Conforming to the manual.	
Main circuit	For public use	Ensure the screws are tightened scurrility	Tighten up	NA
		Ensure there is no distortion, crackles, damage or color-changing caused by overheating and aging to the machine and insulator.	Visual examination	NA

Item to be checked	Details	Check mode	Criterion
	Ensure there is no dust and dirtiness	Visual examination	NA Note: if the color of copper blocks change, it does not mean that there is something wrong with the features.
Conductor lead	Ensure that there is no distortion or color-changing of the conductors caused by overheating.	Visual examination	NA
	Ensure that there are no crackles or color-changing of the protective layers.	Visual examination	NA
Terminals seat	Ensure that there is no damage	Visual examination	NA
Filter capacitors	Ensure that there is no weeping, color-changing, crackles and cassis expansion.	Visual examination	NA
	Ensure the safety valve is in the right place.	Estimate the usage time according to the maintenance or measure the static capacity.	NA
	If necessary, measure the static capacity.	Measure the capacity by instruments.	The static capacity is above or equal to the original value *0.85.
Resistors	Ensure whether there is replacement and splitting caused by overheating.	Smelling and visual examination	NA
	Ensure that there is no offline.	Visual examination or remove one ending to coagulate or measure with	The resistors are in $\pm 10\%$ of the standard value.

Item to be checked		Details	Check mode	Criterion
			multimeters	
	Transformers and reactors	Ensure there is no abnormal vibration, noise and smelling,	Hearing, smelling and visual examination	NA
	Electromagnetic contactor and relay	Ensure whether there is vibration noise in the workrooms.	Hearing	NA
		Ensure the contactor is good enough.	Visual examination	NA
Control circuit	PCB and plugs	Ensure there are no loose screws and contactors.	Fasten up	NA
		Ensure there is no smelling and color-changing.	Smelling and visual examination	NA
		Ensure there are no crackles, damage distortion and rust.	Visual examination	NA
		Ensure there is no weeping and distortion to the capacitors.	Visual examination or estimate the usage time according to the maintenance information	NA
Cooling system	Cooling fan	Estimate whether there is abnormal noise and vibration.	Hearing and Visual examination or rotate with hand	Stable rotation
		Estimate there is no losses screw.	Tighten up	NA
		Ensure there is no color-changing caused by overheating.	Visual examination or estimate the usage time according to the maintenance information	NA

Item to be checked	Details	Check mode	Criterion
	Ventilating duct	Ensure whether there is stuff or foreign objection in the cooling fan, air vent.	Visual examination NA

6.1.2 Cooling fan

The VFD's cooling fan has a minimum life span of 25,000 operating hours. The actual life span depends on the VFD usage and ambient temperature.

The operating hours can be found through P07.14 (accumulative hours of the VFD).

Fan failure can be predicted by the increasing noise from the fan bearings. If the VFD is operated in a critical part of a process, fan replacement is recommended once these symptoms appear. Replacement fans are available from INVT.

	<p>◇ Read and follow the instructions in Chapter 1 "Safety precautions". Ignoring the instructions would cause physical injury or death, or damage to the equipment.</p>
--	--

1. Stop the VFD and disconnect it from the AC power source and wait for at least the time designated on the VFD.
2. Lever the fan holder off the drive frame with a screwdriver and lift the hinged fan holder slightly upward from its front edge.
3. Disconnect the fan cable. Remove the installation bracket.
4. Install the bracket to the reversed direction. Pay attention the air direction of the VFD and the fan as the figure below:

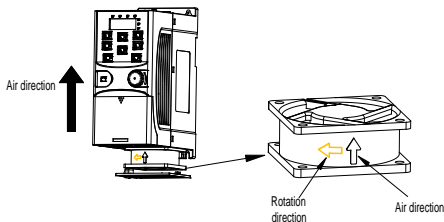
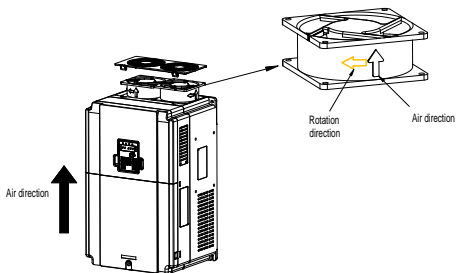

Figure 6-1 Fan installation of the VFDs 1PH, 230V, ≤2.2kW

Figure 6-2 Fan installation of the VFDs 3PH, 400V, $\geq 4\text{kW}$

6.1.3 Capacitor

6.1.3.1 Capacitor reforming

If the VFD has been left unused for a long time, you need to follow the instructions to reform the DC bus capacitor before using it. The storage time is calculated from the date the VFD is delivered.

Storage time	Operational instruction
Less than 1 year	No charging operation is required.
1 to 2 years	The VFD needs to be powered on for 1 hour before the first running command.
2 to 3 years	Use a voltage controlled power supply to charge the VFD: Charge the VFD at 25% of the rated voltage for 30 minutes, and then charge it at 50% of the rated voltage for 30 minutes, at 75% for another 30 minutes, and finally charge it at 100% of the rated voltage for 30 minutes.
More than 3 years	Use a voltage controlled power supply to charge the VFD: Charge the VFD at 25% of the rated voltage for 2 hours, and then charge it at 50% of the rated voltage for 2 hours, at 75% for another 2 hours, and finally charge it at 100% of the rated voltage for 2 hours.

The method of using power surge to charge for the VFD:

The right selection of power surge depends on the supply power of the VFD. Single phase 230V AC/2A power surge applied to the VFD with single/three-phase 230V AC as its input voltage. The VFD with single/three-phase 230V AC as its input voltage can apply Single phase 230V AC/2A power surge (L+ to R and N to S or T). All DC bus capacitors charge at the same time because there is one rectifier.

High-voltage VFD needs enough voltage (for example, 400V) during charging. The small capacitor power (2A is enough) can be used because the capacitor nearly does not need current when charging.

6.1.3.2 Electrolytic capacitor replacement



- ◇ Read and follow the instructions in Chapter 1 "Safety precautions". Ignoring the instructions may cause physical injury or death, or damage to the equipment.

The electrolytic capacitor of the VFD must be replaced if it has been used for more than 35,000 hours. For details about the replacement, contact the local INVT office or dial our national service hotline (400-700-9997).

6.1.4 Power cable



- ◇ Read and follow the instructions in Chapter 1 "Safety precautions". Ignoring the instructions may cause physical injury or death, or damage to the equipment.

1. Stop the drive and disconnect it from the power line. Wait for at least the time designated on the VFD.
2. Check the tightness of the power cable connections.
3. Restore power.

6.2 Fault solution



- ◇ Only qualified electricians are allowed to maintain the VFD. Read the safety instructions in Chapter 1 "Safety precautions" before working on the VFD.

6.2.1 Indications of alarms and faults

Fault is indicated by LEDs. See Chapter 4 "Keypad operation". When **TRIP** light is on, an alarm or fault message on the panel display indicates abnormal VFD state. Using the information given in this chapter, most alarm and fault cause can be identified and corrected. If not, contact with the INVT office.

6.2.2 Fault reset

The VFD can be reset by pressing the keypad key **STOP/RST**, through digital input, or by switching the power light. When the fault has been removed, the motor can be restarted.

6.2.3 VFD faults and solutions

When a fault occurred, handle the fault as follows.

1. Check to ensure there is nothing wrong with the keypad. If no, please contact the local

INVT office.

- If there is nothing wrong, please check P07 and ensure the corresponding recorded fault parameters to confirm the real state when the current fault occurs by all parameters.
- See the following table for detailed solution and check the corresponding abnormal state.
- Eliminate the fault and ask for relative help.
- Check to eliminate the fault and carry out fault reset to run the VFD.

Note: The numbers enclosed in square brackets such as [1], [2] and [3] in the Fault type column in the following table indicate the VFD fault type codes read through communication.

Fault code	Fault type	Possible cause	Solutions
OUt1	[1] Inverter unit U phase protection	<ul style="list-style-type: none"> Acceleration is too fast; IGBT module damaged; Misacts caused by interference; The connection of the drive wire is not good; To-ground short circuit. 	<ul style="list-style-type: none"> Increase acceleration time; Replace the power unit; Check drive wires; Check whether there is strong interference caused by external equipment.
OUt2	[2] Inverter unit V phase protection		
OUt3	[3] Inverter unit W phase protection		
OC1	[4] Overcurrent during acceleration	<ul style="list-style-type: none"> Acceleration is too fast; Grid voltage is too low; VFD power is too small; Load transients or is abnormal; To-ground short circuit or output phase loss occur; There is strong external interference; The overvoltage stall protection is not open. 	<ul style="list-style-type: none"> Increase acceleration time; Check input power; Select the VFD with a larger power; Check if the load is short circuited (to-ground short circuit or line-to-line short circuit) or the rotation is not smooth; Check the output wiring; Check if there is strong interference; Check the setting of related function codes.
OC2	[5] Overcurrent during deceleration		
OC3	[6] Overcurrent during constant speed running		
OV1	[7] Overvoltage during acceleration	<ul style="list-style-type: none"> The input voltage is abnormal; There is large energy 	<ul style="list-style-type: none"> Check the input power; Check if the load deceleration time is too

Fault code	Fault type	Possible cause	Solutions
OV2	[8] Overvoltage during deceleration	feedback; <ul style="list-style-type: none"> ● No brake components; ● Braking energy is not open. 	short or the VFD starts during the rotation of the motor or it is necessary to install dynamic braking components;
OV3	[9] Overvoltage during constant speed running		<ul style="list-style-type: none"> ● Install the brake components; ● Check the setting of related function codes.
UV	[10] Bus undervoltage	<ul style="list-style-type: none"> ● The voltage of the power supply is too low. 	<ul style="list-style-type: none"> ● Check the input power of the supply line.
OL1	[11] Motor overload	<ul style="list-style-type: none"> ● The voltage of the power supply is too low; ● The motor setting rated current is incorrect; ● The motor stall or load transients is too strong. 	<ul style="list-style-type: none"> ● Check grid voltage; ● Reset the rated current of the motor; ● Check the load and adjust the torque lift.
OL2	[12] VFD overload	<ul style="list-style-type: none"> ● Acceleration is too fast; ● Restart the rotating motor ● Grid voltage is too low; ● The load is too heavy; ● The rated power is much larger than the power actually needed. 	<ul style="list-style-type: none"> ● Increase acceleration time; ● Avoid restarting after stopping; ● Check the grid voltage; ● Select a VFD with larger power; ● Select a proper motor.
SPI	[13] Phase loss on input side	<ul style="list-style-type: none"> ● Phase loss or fluctuation of input R, S, T. 	<ul style="list-style-type: none"> ● Check input power ● Check installation wiring.
SPO	[14] Phase loss on output side	<ul style="list-style-type: none"> ● U, V, W phase loss output (or serious asymmetrical three phase of the load). 	<ul style="list-style-type: none"> ● Check the output wiring; ● Check the motor and cable.
OH1	[15] Rectifier module overheat	<ul style="list-style-type: none"> ● Air duct is blocked or fan is damaged; ● Ambient temperature is too high; ● The time of overload running is too long. 	<ul style="list-style-type: none"> ● Refer to the overcurrent solution; ● Redistribute; ● Dredge the wind channel or change the fan; ● Lower down the ambient

Fault code	Fault type	Possible cause	Solutions
OH2	[16] Inverter module overheat		temperature; <ul style="list-style-type: none"> ● Check and reconnect; ● Change the power; ● Change the power unit; ● Change the main control panel.
EF	[17] External fault	<ul style="list-style-type: none"> ● SI external fault input terminals acts. 	<ul style="list-style-type: none"> ● Check the external device input.
CE	[18] 485 communication fault	<ul style="list-style-type: none"> ● The baud rate setting is incorrect; ● Fault occurs to the communication circuit; ● The communication address is wrong; ● There is strong interference to the communication. 	<ul style="list-style-type: none"> ● Set proper baud rate; ● Check the wiring of communication connection interface; ● Set proper communication address; ● Change or replace the wiring or improve the anti-interference capability.
ItE	[19] Current detection fault	<ul style="list-style-type: none"> ● The connection of the control board is not good; ● Assistant power is bad; ● Hall components is broken; ● The magnifying circuit is abnormal. 	<ul style="list-style-type: none"> ● Check the connector and plug wire again; ● Change the hall; ● Change the main control panel.
tE	[20] Motor autotuning fault	<ul style="list-style-type: none"> ● The motor capacity does not match with VFD capacity; ● The rated parameter of the motor is set improperly; ● The deviation between the parameters from autotune and the standard parameter is huge; ● Autotune overtime. 	<ul style="list-style-type: none"> ● Change the VFD model; Set the rated parameter according to the motor nameplate; ● Empty the motor load; Check the motor connection and set the parameter; ● Check if the upper limit frequency is above 2/3 of the rated frequency.
EEP	[21] EEPROM operation fault	<ul style="list-style-type: none"> ● Error occurred to R/W of the control parameter; 	<ul style="list-style-type: none"> ● Press STOP/RST to reset; ● Change the main control

Fault code	Fault type	Possible cause	Solutions
		<ul style="list-style-type: none"> ● EEPROM is damaged. 	panel.
PIDE	[22] PID feedback offline fault	<ul style="list-style-type: none"> ● PID feedback offline; ● PID feedback source disappear. 	<ul style="list-style-type: none"> ● Check the PID feedback signal wire; ● Check the PID feedback source.
bCE	[23] Braking unit fault	<ul style="list-style-type: none"> ● Braking circuit fault or damage to the brake pipes; ● The external braking resistor is not sufficient. 	<ul style="list-style-type: none"> ● Check the braking unit and change to new brake pipe; ● Increase the braking resistor.
END	[24] Running time reached	<ul style="list-style-type: none"> ● The actual running time of the VFD is larger than the internal setting running time. 	<ul style="list-style-type: none"> ● Ask for the supplier and adjust the setting running time.
OL3	[25] Electronic overload	<ul style="list-style-type: none"> ● The VFD will report overload pre-alarm according to the set value. 	<ul style="list-style-type: none"> ● Check the load and the overload pre-alarm point.
PCE	[26] Keypad communication error	<ul style="list-style-type: none"> ● The keypad is not in good connection or offline; ● The keypad cable is too long and there is strong interference; ● Part of the communication circuits of the keypad or main board have fault. 	<ul style="list-style-type: none"> ● Check the keypad cable and ensure it is normal; ● Check the environment and eliminate the interference source; ● Change hardware and ask for maintenance service.
UPE	[27] Parameter upload error	<ul style="list-style-type: none"> ● The keypad is not in good connection or offline; ● The keypad cable is too long and there is strong interference; ● Part of the communication circuits of the keypad or main board have fault. 	<ul style="list-style-type: none"> ● Check the environment and eliminate the interference source; ● Replace the hardware and ask for maintenance service; ● Change hardware and ask for maintenance service.
DNE	[28] Parameter download error	<ul style="list-style-type: none"> ● The keypad is not in good connection or offline; ● The keypad cable is too long and there is strong interference; 	<ul style="list-style-type: none"> ● Check the environment and eliminate the interference source; ● Replace the hardware and ask for maintenance

Fault code	Fault type	Possible cause	Solutions
		<ul style="list-style-type: none"> Data storage error in keypad. 	service; <ul style="list-style-type: none"> Backup data in the keypad again.
ETH1	[32] To-ground short-circuit fault 1	<ul style="list-style-type: none"> The output of the VFD is short circuited to the ground; There is fault in the current detection circuit; There is a great difference between the actual motor power setting and the VFD power. 	<ul style="list-style-type: none"> Check if the connection of the motor is normal or not; Replace the hall; Replace the main control panel; Reset motor parameters and ensure those parameters are correct; Check whether motor power parameters in P2 group are consistent with the motor power actually used.
ETH2	[33] To-ground short-circuit fault 2		
LL	[36] Electronic underload fault	<ul style="list-style-type: none"> The VFD will report the underload pre-alarm according to the set value. 	<ul style="list-style-type: none"> Check the load and the underload pre-alarm point.
STO	[37] Safe torque off	<ul style="list-style-type: none"> STO function operates normally 	
STL1	[38] Channel H1 abnormal	<ul style="list-style-type: none"> Fault or internal hardware circuit fault occurred to H1 channel 	<ul style="list-style-type: none"> Replace STO switch; if problem persists after replacement, contact the manufacturer.
STL2	[39] Channel H2 abnormal	<ul style="list-style-type: none"> Fault or internal hardware circuit fault occurred to H2 channel 	
STL3	[40] Internal circuit abnormal	<ul style="list-style-type: none"> Fault or internal hardware circuit fault occurred to H1 and H2 channels simultaneously 	
CrCE	[41] Safe code FLASH CRC check fault	<ul style="list-style-type: none"> Error occurred to STO safe code FLASH CRC check 	<ul style="list-style-type: none"> Contact the manufacturer.
OH3	[42] AIAO overtemperature	<ul style="list-style-type: none"> Motor overtemperature input terminal is valid. The temperature detection 	<ul style="list-style-type: none"> Check the wiring of the motor overtemperature input terminal.

Fault code	Fault type	Possible cause	Solutions
		resistance is abnormal. <ul style="list-style-type: none"> Long-time overload running or exception occurred. 	<ul style="list-style-type: none"> Check whether the temperature sensor is proper. Check the motor and perform maintenance on the motor.

STO alarm

1. When the hundreds of P11.16 is set to 0, the STO alarm is locked.

As shown in below fig 1, When H1 and H2 are 'OFF' during operation (safety function is required), the drive enters safety mode and stops output. STO alarm will only be disappeared once reset action is valid. External running command need to be reset for the drive to execute running command again.

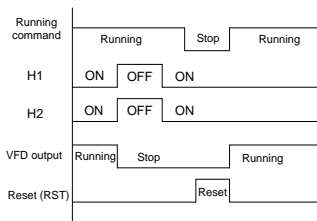

2. When the hundreds of P11.16 is set to 1, the STO alarm will be unlocked

As shown in below fig 2, alarm unlock means when STO appears, the STO alarm will disappear automatically after state restoration, which requires no reset action. After reset of external running command, the drive will execute running command again.

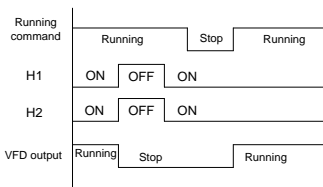

STL1 fault

As shown in below fig 3, when the hardware circuit of safety circuit 1 is abnormal while that of H2 signal is normal, namely, when H1 is abnormal during operation (safety function is required), the drive enters safety mode and stops output no matter whatever the running command is. Despite of reset commands and external running command reset, the drive will not execute running command again, and it is STL1 alarm locked all the time.

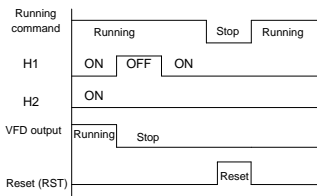

STL 2 fault

As shown in below fig 4, when the hardware circuit of safety circuit 2 is abnormal while that of H1 signal is normal, namely, when H2 is abnormal during operation (safety function is required), the drive enters safety mode and stops output no matter whatever the running command is. Despite of reset commands and external running command reset, the drive will not execute running command again, and it is STL2 alarm locked all the time.

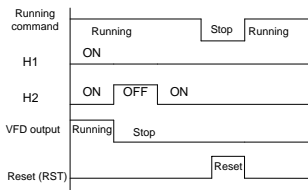

6.2.4 Other states

Fault code	Fault type	Possible cause	Solutions
PoFF	System power off	<ul style="list-style-type: none"> System power off or low DC voltage. 	<ul style="list-style-type: none"> Check the grid.

Chapter 7 Communication protocol

7.1 Modbus protocol introduction

Modbus protocol is a software protocol and common language which is applied in the electrical controller. With this protocol, the controller can communicate with other devices via network (the channel of signal transmission or the physical layer, such as RS485). And with this industrial standard, the controlling devices of different manufacturers can be connected to an industrial network for the convenient of being monitored.

There are two transmission modes for Modbus protocol: ASCII mode and RTU (Remote Terminal Units) mode. On one Modbus network, all devices should select same transmission mode and their basic parameters, such as baud rate, digital bit, check bit, and stopping bit should have no difference.

Modbus network is a controlling network with single-master and multiple slaves, which means that there is only one device performs as the master and the others are the slaves on one Modbus network. The master means the device which has active talking right to send message to Modbus network for the controlling and inquiring to other devices. The slave means the passive device which sends data message to the Modbus network only after receiving the controlling or inquiring message (command) from the master (response). After the master sends message, there is a period of time left for the controlled or inquired slaves to response, which ensure there is only one slave sends message to the master at a time for the avoidance of singles impact.

Generally, the user can set PC, PLC, IPC and HMI as the masters to realize central control. Setting certain device as the master is a promise other than setting by a bottom or a switch or the device has a special message format. For example, when the upper monitor is running, if the operator clicks sending command bottom, the upper monitor can send command message actively even it cannot receive the message from other devices. In this case, the upper monitor is the master. And if the designer makes the VFD send the data only after receiving the command, then the VFD is the slave.

The master can communicate with any single slave or with all slaves. For the single-visiting command, the slave should feedback a response message; for the broadcasting message from the master, the slave does not need to feedback the response message.

7.2 Application

The Modbus protocol of the VFD is RTU mode and the physical layer is 2-wire RS485.

7.2.1 Two-wire RS485

The interface of 2-wire RS485 works on half-duplex and its data signal applies differential transmission which is called balance transmission, too. It uses twisted pairs, one of which is defined as A (+) and the other is defined as B (-). Generally, if the positive electrical level

between sending drive A and B is among +2—+6V, it is logic "1", if the electrical level is among -2V—6V; it is logic "0".

485+ on the terminal board corresponds to A and 485- to B.

Communication baud rate means the binary bit number in one second. The unit is bit/s (bps). The higher the baud rate is, the quicker the transmission speed is and the weaker the anti-interference is. If the twisted pairs of 0.56mm (24AWG) is applied as the communication cables, the max. transmission distance is as follows:

Baud rate	Max. transmission distance	Baud rate	Max. transmission distance	Baud rate	Max. transmission distance	Baud rate	Max. transmission distance
2400 BPS	1800m	4800 BPS	1200m	9600 BPS	800m	19200 BPS	600m

It is recommended to use shield cables and make the shield layer as the grounding wires during RS485 remote communication.

In the cases with less devices and shorter distance, it is recommended to use 120Ω terminal resistor as the performance will be weakened if the distance increase even though the network can perform well without load resistor.

7.2.1.1 When one VFD is used

Figure 7-1 is the site Modbus connection figure of single VFD and PC. Generally, the computer does not have RS485 interface, the RS232 or USB interface of the computer should be converted into RS485 by converter. Connect the A terminal of RS485 to the 485+ terminal of the VFD and B to the 485- terminal. It is recommended to use the shield twisted pairs. When applying RS232-RS485 converter, if the RS232 interface of the computer is connected to the RS232 interface of the converter, the wire length should be as short as possible within the length of 15m. It is recommended to connect the RS232-RS485 converter to the computer directly. If using USB-RS485 converter, the wire should be as short as possible, too.

Select a right interface to the upper monitor of the computer (select the interface of RS232-RS485 converter, such as COM1) after the wiring and set the basic parameters such as communication baud rate and digital check bit to the same as the VFD.

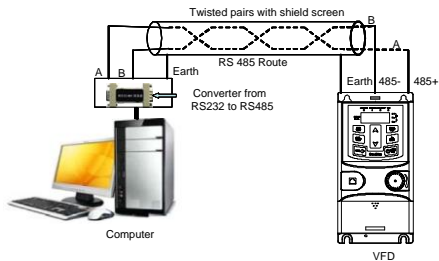

Figure 7-1 RS485 wiring diagram for the network with one VFD

7.2.1.2 When multiple VFDs are used

In real multi-applications, the chrysanthemum connection and star connection are commonly used.

Chrysanthemum chain connection is required in the RS485 industrial fieldbus standards. The two ends are connected to terminal resistors of 120Ω which is shown as Figure 7-2.

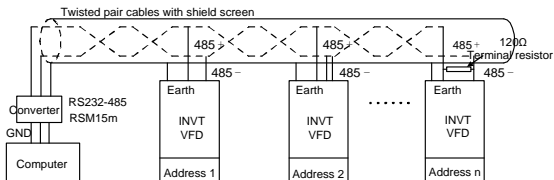

Figure 7-2 Practical application diagram of chrysanthemum connection

Figure 7-3 is the star connection. Terminal resistor should be connected to the two devices which have the longest distance. (1# and 15# device)

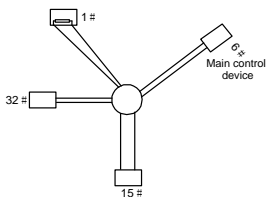

Figure 7-3 Star connection

It is recommended to use shield cables in multiple connection. The basic parameter of the devices, such as baud rate and digital check bit in RS485 should be the same and there should be no repeated address.

7.2.2 RTU mode

7.2.2.1 RTU communication frame structure

If the controller is set to communicate by RTU mode in Modbus network every 8bit byte in the message includes two 4Bit hex characters. Compared with ACSII mode, this mode can send more data at the same baud rate.

Code system

- 1 start bit
- 7 or 8 digital bit, the minimum valid bit can be sent firstly. Every 8 bit frame includes two hex characters (0...9, A...F)
- 1 even/odd check bit. If there is no checkout, the even/odd check bit is inexistent.
- 1 stop bit (with checkout), or 2 bit (no checkout)

Error detection domain

- CRC

The data format is illustrated as below:

11-bit character frame (BIT1–BIT8 are the digital bits)

Start bit	BIT1	BIT2	BIT3	BIT4	BIT5	BIT6	BIT7	BIT8	Check bit	Stop bit
-----------	------	------	------	------	------	------	------	------	-----------	----------

10-bit character frame (BIT1–BIT7 are the digital bits)

Start bit	BIT1	BIT2	BIT3	BIT4	BIT5	BIT6	BIT7	Check bit	Stop bit
-----------	------	------	------	------	------	------	------	-----------	----------

In one character frame, the digital bit takes effect. The start bit, check bit and stop bit is used to send the digital bit right to the other device. The digital bit, even/odd checkout and stop bit should be set as the same in real application.

The Modbus minimum idle time between frames should be no less than 3.5 bytes. The network device is detecting, even during the interval time, the network bus. When the first field (the address field) is received, the corresponding device decodes next transmitting character. When the interval time is at least 3.5 byte, the message ends.

The whole message frame in RTU mode is a continuous transmitting flow. If there is an interval time (more than 1.5 bytes) before the completion of the frame, the receiving device will renew the uncompleted message and suppose the next byte as the address field of the new

message. As such, if the new message follows the previous one within the interval time of 3.5 bytes, the receiving device will deal with it as the same with the previous message. If these two phenomena all happen during the transmission, the CRC will generate a fault message to respond to the sending devices.

The standard structure of RTU frame:

START	T1-T2-T3-T4 (transmission time of 3.5 bytes)
ADDR	Communication address: 0–247 (decimal system) (0 is the broadcast address)
CMD	03H: read slave parameters 06H: write slave parameters
DATA (N-1) ... DATA (0)	The data of 2*N bytes are the main content of the communication as well as the core of data exchanging
CRC CHK low bit	Detection value: CRC (16BIT)
CRC CHK high bit	
END	T1-T2-T3-T4 (transmission time of 3.5 bytes)

7.2.2.2 RTU communication frame error check modes

Various factors (such as electromagnetic interference) may cause error in the data transmission. For example, if the sending message is a logic "1", A-B potential difference on RS485 should be 6V, but in reality, it may be -6V because of electromagnetic interference, and then the other devices take the sent message as logic "0". If there is no error checkout, the receiving devices will not find the message is wrong and they may give incorrect response which cause serious result. So the checkout is essential to the message.

The theme of checkout is that: the sender calculate the sending data according to a fixed formula, and then send the result with the message. When the receiver gets this message, they will calculate another result according to the same method and compare it with the sending one. If two results are the same, the message is correct. If no, the message is incorrect.

The error checkout of the frame can be divided into two parts: the bit checkout of the byte and the whole data checkout of the frame (CRC check).

Bit check on individual bytes (odd/even check)

The user can select different bit checkouts or non-checkout, which impacts the check bit setting of each byte.

The definition of even checkout: add an even check bit before the data transmission to illustrate the number of "1" in the data transmission is odd number or even number. When it is even, the check byte is "0"; otherwise, the check byte is "1". This method is used to stabilize the parity of the data.

The definition of odd checkout: add an odd check bit before the data transmission to illustrate the number of "1" in the data transmission is odd number or even number. When it is odd, the check byte is "0"; otherwise, the check byte is "1". This method is used to stabilize the parity of the data.

For example, when transmitting "11001110", there are five "1" in the data. If the even checkout is applied, the even check bit is "1"; if the odd checkout is applied; the odd check bit is "0". The even and odd check bit is calculated on the check bit position of the frame. And the receiving devices also carry out even and odd checkout. If the parity of the receiving data is different from the setting value, there is an error in the communication.

Cyclical Redundancy Check (CRC) method

The checkout uses RTU frame format. The frame includes the frame error detection field which is based on the CRC calculation method. The CRC field is two bytes, including 16 figure binary values. It is added into the frame after calculated by transmitting device. The receiving device recalculates the CRC of the received frame and compares them with the value in the received CRC field. If the two CRC values are different, there is an error in the communication.

During CRC, 0*FFFF will be stored. And then, deal with the continuous 6-above bytes in the frame and the value in the register. Only the 8Bit data in every character is effective to CRC, while the start bit, the end and the odd and even check bit is ineffective.

The calculation of CRC applies the international standard CRC checkout principles. When the user is editing CRC calculation, he can refer to the relative standard CRC calculation to write the required CRC calculation program.

Here provided a simple function of CRC calculation for the reference (programmed with C language):

```
unsigned int crc_cal_value(unsigned char *data_value,unsigned char
data_length)
{
int i;
unsigned int crc_value=0xffff;
while(data_length--)
{
  crc_value^=*data_value++;
  for(i=0;i<8;i++)
  {
if(crc_value&0x0001)crc_value=(crc_value>>1)^0xa001;
else crc_value=crc_value>>1;
}
}
}
```

```
return (crc_value);
}
```

In ladder logic, CKSM calculated the CRC value according to the frame with the table inquiry. The method is advanced with easy program and quick calculation speed. But the ROM space the program occupied is huge. So use it with caution according to the program required space.

7.2.3 ASCII mode

Name	Definition									
Coding system	Communication protocol belongs to hexadecimal system. The meaning of message character in ASCII: "0"... "9", "A"... "F", each hex is represented by the ASCII message corresponds to the character.									
	Character	'0'	'1'	'2'	'3'	'4'	'5'	'6'	'7'	
	ASCII CODE	0x30	0x31	0x32	0x33	0x34	0x35	0x36	0x37	
	Character	'8'	'9'	'A'	'B'	'C'	'D'	'E'	'F'	
	ASCII CODE	0x38	0x39	0x41	0x42	0x43	0x44	0x45	0x46	
Data format	Starting bit, 7/8 data bit, check bit and stop bit. The data formats are listed as below: 11-bit character frame:									
	Starting bit	BIT1	BIT2	BIT3	BIT4	BIT5	BIT6	BIT7	BIT8	Check bit
	10-bit character frame:									
	Starting bit	BIT1	BIT2	BIT3	BIT4	BIT5	BIT6	BIT7	Check bit	Stop bit

In ASCII mode, the frame header is ":" ("0*3A"), frame end is "CRLF" ("0*0D" "0*0A") by default. In ASCII mode, all the data bytes, except for the frame header and frame end, are transmitted in ASCII code mode, in which four high bit groups will be sent out first and then, four low bit groups will be sent out. In ASCII mode, the data length is 8 bit. As for 'A'-'F', its capital letters is adopted for ASCII code. The data now adopts LRC checkout which covers slave address to data information. The checksum equals to the complement of the character sum of all the participated checkout data.

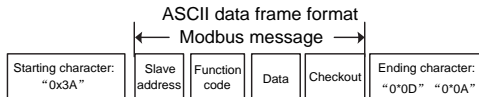

Standard structure of ASCII frame:

START	':' (0x3A)
Address Hi	Communication address:
Address Lo	8-bit address is formed by the combination of two ASCII codes

Function Hi	Function code: 8-bit address is formed by the combination of two ASCII codes
Function Lo	
DATA (N-1) ... DATA (0)	Data content: nx8-bit data content is formed by combination of 2n (n≤16) ASCII codes
LRC CHK Hi	LRC check code: 8-bit check code is formed by the combination of two ASCII codes.
LRC CHK Lo	
END Hi	End character: END Hi=CR (0x0D), END Lo=LF (0x0A)
END Lo	

7.2.3.1 ASCII mode check (LRC Check)

Check code (LRC Check) is the value combined of address and data content result. For instance, the check code of above 2.2.2 communication message is: 0x02+0x06+0x00+0x08+0x13+0x88=0xAB, then take the compliment of 2=0x55. Below is a simple LRC calculation function for user reference (programed with C language):

```
Static unsigned char
```

```
LRC (auchMsg, usDataLen)
```

```
unsigned char *auchMsg;
```

```
unsigned short usDataLen;
```

```
{
unsigned char uchLRC=0;
while(usDataLen-->0)
uchLRC+=*auchMsg++;
return((unsigned char)( - ((char)uchLRC)));
}
```

7.3 RTU command code and communication data

7.3.1 RTU mode

7.3.1.1 Command code: 03H

03H (correspond to binary 0000 0011), reading N words (N ≤ 16)

Command code 03H means that if the master read data from the VFD, the data number depends on the "data number" in the command code. The max. number is 16 and the parameter address to be read must be continuous. The length of every data is 2 bytes (one word). The following command format is illustrated in hex (a number with "H" means hex) and one hex number occupies one byte.

This command code is used to read the working state of the VFD.

For example, read continuous 2 data content from 0004H from the VFD with the address of 01H (read the content of data address of 0004H and 0005H), the frame structure is as follows:

RTU master command message (from the master to the VFD)

START	T1-T2-T3-T4
ADDR	01H
CMD	03H
High bit of the start address	00H
Low bit of the start address	04H
High bit of data number	00H
Low bit of data number	02H
CRC low bit	85H
CRC high bit	CAH
END	T1-T2-T3-T4

T1-T2-T3-T4 between START and END is to provide at least the time of 3.5 bytes as the leisure time and distinguish two messages for the avoidance of taking two messages as one message.

ADDR = 01H means the command message is sent to the VFD with the address of 01H and ADDR occupies one byte

CMD=03H means the command message is sent to read data from the VFD and CMD occupies one byte

"Start address" means reading data from the address and it occupies 2 bytes with the fact that the high bit is in the front and the low bit is in the behind.

"Data number" means the reading data number with the unit of word. If the "start address" is 0004H and the "data number" is 0002H, the data of 0004H and 0005H will be read.

CRC occupies 2 bytes with the high bit in the front and the low bit in the behind.

RTU slave response message (from the VFD to the master)

START	T1-T2-T3-T4
ADDR	01H
CMD	03H
Byte number	04H
Data high bit of address 0004H	13H
Data low bit of address 0004H	88H
Data high bit of address 0005H	00H

Data low bit of address 0005H	00H
CRC CHK low bit	7EH
CRC CHK high bit	9DH
END	T1-T2-T3-T4

The meaning of the response is that:

ADDR = 01H means the command message is sent to the VFD with the address of 01H and ADDR occupies one byte

CMD=03H means the message is received from the VFD to the master for the response of reading command and CMD occupies one byte

"Byte number" means all byte number from the byte (excluding the byte) to CRC byte (excluding the byte). 04 means there are 4 byte of data from the "byte number" to "CRC CHK low bit", which are "digital address 0004H high bit", "digital address 0004H low bit", "digital address 0005H high bit" and "digital address 0005H low bit".

There are 2 bytes stored in one data with the fact that the high bit is in the front and the low bit is in the behind of the message, the data of data address 0004H is 1388H, and the data of data address 0005H is 0000H.

CRC occupies 2 bytes with the fact that the high bit is in the front and the low bit is in the behind.

7.3.1.2 Command code: 06H

06H (correspond to binary 0000 0110), writing a word

The command means the master writes data to the VFD and one command can write one data only. It is used to change the parameter and working mode of the VFD.

For example, write 5000 (1388H) to 0004H from the VFD with the address of 02H, the frame structure is as follows:

RTU master command message (from the master to the VFD)

START	T1-T2-T3-T4
ADDR	02H
CMD	06H
High bit of writing data address	00H
Low bit of writing data address	04H
High bit of data content	13H
Low bit of data content	88H
CRC CHK low bit	C5H
CRC CHK high bit	6EH
END	T1-T2-T3-T4

RTU slave response message (from the VFD to the master)

START	T1-T2-T3-T4
ADDR	02H
CMD	06H
High bit of writing data address	00H
Low bit of writing data address	04H
High bit of data content	13H
Low bit of data content	88H
CRC CHK low bit	C5H
CRC CHK high bit	6EH
END	T1-T2-T3-T4

Note: Sections 7.3.1.1 and 7.3.1.2 mainly describe the command formats.

7.3.1.3 Command code 10H, continuous writing

Command code 10H means that if the master writes data to the VFD, the data number depends on the "data number" in the command code. The max. continuous reading number is 16.

For example, write 5000 (1388H) to 0004H of the VFD whose slave address is 02H and 50 (0032H) to 0005H, the frame structure is as follows:

The RTU request command is:

START	T1-T2-T3-T4 (transmission time of 3.5 bytes)
ADDR	02H
CMD	10H
High bit of write data	00H
Low bit of write data	04H
High bit of data number	00H
Low bit of data number	02H
Byte number	04H
High bit of data 0004H	13H
Low bit of data 0004H	88H
High bit of data 0005H	00H
Low bit of data 0005H	32H
Low bit of CRC	C5H
High bit of CRC	6EH
END	T1-T2-T3-T4 (transmission time of 3.5 bytes)

The RTU response command is:

START	T1-T2-T3-T4 (transmission time of 3.5 bytes)
ADDR	02H
CMD	10H
High bit of write data	00H
Low bit of write data	04H
High bit of data number	00H
Low bit of data number	02H
Low bit of CRC	C5H
High bit of CRC	6EH
END	T1-T2-T3-T4 (transmission time of 3.5 bytes)

7.3.2 ASCII mode

7.3.2.1 Command code 03H (0000 0011), reading N words (N ≤ 16)

For instance: As for the VFD whose slave address is 01H, the starting address of internal storage is 0004, read two words continuously, the structure of this frame is listed as below:

ASCII master command message (the command sent from the master to the VFD)		ASCII slave response message (the message sent from the VFD to the master)	
START	':'	START	':'
ADDR	'0'	ADDR	'0'
	'1'		'1'
CMD	'0'	CMD	'0'
	'3'		'3'
High bit of starting address	'0'	Byte number	'0'
	'0'		'4'
Low bit of starting address	'0'	High bit of data address 0004H	'1'
	'4'		'3'
High bit of data number	'0'	Low bit of data address 0004H	'8'
	'0'		'8'
Low bit of data number	'0'	High bit of data address 0005H	'0'
	'2'		'0'
LRC CHK Hi	'F'	Low bit of data address 0005H	'0'
LRC CHK Lo	'6'		'0'
END Hi	CR	LRC CHK Hi	'5'
END Lo	LF	LRC CHK Lo	'D'
		END Hi	CR
		END Lo	LF

7.3.2.2 Command code 06H (0000 0110), writing a word

For instance: Write 5000 (1388H) to the 0004H address of the VFD whose slave address is 02H, then the structure of this frame is listed as below:

ASCII master command message (the command sent by the master to VFD)		ASCII slave response message (the message sent by the VFD to master)	
START	':'	START	':'
ADDR	'0'	ADDR	'0'
	'2'		'2'
CMD	'0'	CMD	'0'
	'6'		'6'
High bit of write data	'0'	High bit of write data	'0'
	'0'		'0'
Low bit of write data	'0'	Low bit of write data	'0'
	'4'		'4'
High bit of data content	'1'	High bit of data content	'1'
	'3'		'3'
Low bit of data content	'8'	Low bit of data content	'8'
	'8'		'8'
LRC CHK Hi	'5'	LRC CHK Hi	'5'
LRC CHK Lo	'9'	LRC CHK Lo	'9'
END Hi	CR	END Hi	CR
END Lo	LF	END Lo	LF

7.3.2.3 Command code 08H (0000 1000), diagnosis

Meaning of sub function code:

Sub function code	Description
0000	Return inquiry message data

For instance: carry out circuit detection on drive address 01H, the content of inquiry message word string is the same with response message word string, its format is listed as below:

ASCII master command message (the command sent by the master to VFD)		ASCII slave response message (the message sent by the VFD to master)	
START	':'	START	':'
ADDR	'0'	ADDR	'0'
	'1'		'1'
CMD	'0'	CMD	'0'
	'8'		'8'
High bit of write data address	'0'	High bit of write data address	'0'
	'0'		'0'

ASCII master command message (the command sent by the master to VFD)		ASCII slave response message (the message sent by the VFD to master)	
Low bit of write data address	'0'	Low bit of write data address	'0'
	'0'		'0'
High bit of data content	'1'	High bit of data content	'1'
	'2'		'2'
Low bit of data content	'A'	Low bit of data content	'A'
	'B'		'B'
LRC CHK Hi	'3'	LRC CHK Hi	'3'
LRC CHK Lo	'A'	LRC CHK Lo	'A'
END Hi	CR	END Hi	CR
END Lo	LF	END Lo	LF

7.3.2.4 Command code 10H, continuous writing

Command code 10H means the master write data to the VFD, the number of data being written is determined by the command "data number", the max. number of continuous writing is 16 words.

For instance: Write 5000 (1388H) to 0004H of the VFD whose slave address is 02H, write 50 (0032H) to 0005H of the VFD whose slave address is 02H, then the structure of this frame is listed as below:

ASCII master command message (the command sent by the master to VFD)		ASCII slave response message (the message sent by the VFD to master)	
START	':'	START	':'
ADDR	'0'	ADDR	'0'
	'2'		'2'
CMD	'1'	CMD	'1'
	'0'		'0'
High bit of starting address	'0'	High bit of starting address	'0'
	'0'		'0'
Low bit of starting address	'0'	Low bit of starting address	'0'
	'4'		'4'
High bit of data number	'0'	High bit of data number	'0'
	'0'		'0'
Low bit of data number	'0'	Low bit of data number	'0'
	'2'		'2'
Byte number	'0'	LRC CHK Hi	'E'
	'4'	LRC CHK Lo	'8'
High bit of data 0004H content	'1'	END Hi	CR
	'3'	END Lo	LF

ASCII master command message (the command sent by the master to VFD)		ASCII slave response message (the message sent by the VFD to master)	
Low bit of data 0004H content	'8'		
	'8'		
High bit of data 0005H content	'0'		
	'0'		
Low bit of data 0005H content	'3'		
	'2'		
LRC CHK Hi	'1'		
LRC CHK Lo	'7'		
END Hi	CR		
END Lo	LF		

7.4 Data address definition

The address definition of the communication data in this part is to control the running of the VFD and get the state information and relative function parameters of the VFD.

7.4.1 Function code address format rules

The parameter address occupies 2 bytes with the most significant byte (MSB) in the front and the least significant byte (LSB) in the behind. The ranges of the MSB and LSB are: MSB—00–ffH; LSB—00–ffH. The MSB is the group number before the radix point of the function code and the LSB is the number after the radix point, but both the MSB and the LSB should be converted into hex. For example, P05.05, the group number before the radix point of the function code is 05, then the MSB of the parameter is 05, the number after the radix point 05, then the LSB the parameter is 05, then the function code address is 0505H and the parameter address of P10.01 is 0A01H.

Function code	Name	Description	Default	Modify
P10.00	Simple PLC mode	0: Stop after running once. 1: Keep running in the final value after running once. 2: Cyclic running.	0	<input type="radio"/>
P10.01	Simple PLC memory selection	0: No memory after power-off 1: Memory after power-off	0	<input type="radio"/>

Note: P29 group is the factory parameter which cannot be read or changed. Some parameters cannot be changed when the VFD is in the running state and some parameters cannot be changed in any state. The setting range, unit and relative instructions should be paid attention to when modifying the function code parameters.

Besides, EEPROM is stocked frequently, which may shorten the usage time of EEPROM. For users, some functions are not necessary to be stocked on the communication mode. The needs can be met on by changing the value in RAM. Changing the high bit of the function code form 0 to 1 can also realize the function. For example, the function code P00.07 is not stocked into EEPROM. Only by changing the value in RAM can set the address to 8007H. This address can only be used in writing RAM other than reading. If it is used to read, it is an invalid address.

7.4.2 Description of other function addresses in Modbus

The master can operate on the parameters of the VFD as well as control the VFD, such as running or stopping and monitoring the working state of the VFD.

Below is the parameter table of other functions.

Function	Address	Data description	R/W characteristics
Communication control command	2000H	0001H: Forward running	R/W
		0002H: Reverse running	
		0003H: Forward jogging	
		0004H: Reverse jogging	
		0005H: Stop	
		0006H: Coast to stop	
		0007H: Fault reset	
		0008H: Jogging stop	
Address of the communication n setting value	2001H	Communication setting frequency (0–Fmax(unit: 0.01Hz))	R/W
	2002H	PID reference, range (0–1000, 1000 corresponds to100.0%)	R/W
	2003H	PID feedback, range (0–1000, 1000 corresponds to100.0%)	R/W
	2004H	Torque setting value (-3000–3000, 1000 corresponds to the 100.0% of the rated current of the motor)	R/W
	2005H	The upper limit frequency setting during forward rotation (0–Fmax (unit: 0.01Hz))	R/W
	2006H	The upper limit frequency setting during reverse rotation (0–Fmax (unit: 0.01Hz))	R/W
	2007H	The upper limit torque of electromotion torque (0–3000, 1000	R/W

Function	Address	Data description	R/W characteristics
		corresponds to the 100.0% of the rated current of the motor)	
	2008H	The upper limit torque of braking torque (0–3000, 1000 corresponds to the 100.0% of the rated current of the motor)	R/W
	2009H	Special control command word Bit0–1: =00: motor 1 =01: motor 2 =10: motor 3 =11: motor 4 Bit2: =1 torque control prohibit =0: torque control prohibit invalid Bit3: =1 power consumption clear =0: no power consumption clear Bit4: =1 pre-exciting =0: pre-exciting prohibition Bit5: =1 DC braking =0: DC braking prohibition	R/W
	200AH	Virtual input terminal command, range: 0x000–0x1FF	R/W
	200BH	Virtual output terminal command, range: 0x00–0x0F	R/W
	200CH	Voltage setting value (special for V/F separation) (0–1000, 1000 corresponds to the 100.0% of the rated voltage of the motor)	R/W
	200DH	AO output setting 1 (-1000–1000, 1000 corresponds to 100.0%)	R/W
	200EH	AO output setting 2 (-1000–1000, 1000 corresponds to 100.0%)	R/W
SW 1 of the VFD	2100H	0001H: Forward running	R
		0002H: Forward running	
		0003H: Stop	
		0004H: Fault	
		0005H: POFF state	
		0006H: Pre-exciting state	

Function	Address	Data description	R/W characteristics
SW 1 of the VFD	2101H	Bit0: =0: bus voltage is not established =1: bus voltage is established Bit1-2: =00: motor 1 =01: motor 2 =10: motor 3 =11: motor 4 Bit3: =0: asynchronous motor =1: synchronous motor Bit4: =0: pre-alarm without overload =1: overload pre-alarm Bit5- Bit6 :=00: keypad control =01: terminal control =10: communication control	R
VFD fault code	2102H	See the fault type instruction	R
Identifying code of the VFD	2103H	GD20-EU-----0x0180	R
Running frequency	3000H	0-Fmax, unit: 0.01Hz	Compatible with the communication addresses of GD, CHF100A, and CHV100 series.
Set frequency	3001H	0-Fmax, unit: 0.01Hz	
Bus voltage	3002H	0.0-2000.0V, unit: 0.1V	
Output voltage	3003H	0-1200V, unit: 1V	
Output current	3004H	0.0-3000.0A, unit: 0.1A	
Rotating speed	3005H	0-65535, unit: 1RPM	
Output power	3006H	-300.0-300.0%, unit: 0.1%	
Output torque	3007H	-250.0-250.0%, unit: 0.1%	
PID setting	3008H	-100.0-100.0%, unit: 0.1%	
PID feedback	3009H	-100.0-100.0%, unit: 0.1%	
Input state	300AH	000-1FF	
Input state	300BH	000-1FF	
AI 1	300CH	0.00-10.00V, unit:	

Function	Address	Data description		R/W characteristics
		0.01V		
AI 2	300DH	0.00–10.00V, unit: 0.01V		R
AI 3	300EH	-10.00–10.00V, unit: 0.01V		R
AI 4	300FH	Reserved		R
Read input of high speed pulse 1	3010H	0.000–50.000kHz, unit: 0.01Hz		R
Read input of high speed pulse 2	3011H	Reserved		R
PLC and current step of multi-step speed	3012H	0–15		R
External length	3013H	0–65535		R
External count value	3014H	0–65535		R
Torque setting	3015H	-300.0–300.0%, unit: 0.1%		R
VFD identification code	3016H			R
Fault code	5000H		R	

R/W characteristics means the function is with read and write characteristics. For example, "communication control command" is writing characteristics and control the VFD with writing command (06H). R characteristic can only read other than write and W characteristic can only write other than read.

Note: When operating on the VFD with the table above, it is necessary to enable some parameters. For example, the operation of running and stopping, it is necessary to set P00.01 to communication running command channel.

The encoding rules for device codes (corresponds to identifying code 2103H of the VFD)

MSB of code	Meaning	LSB of code	Meaning
01	Goodrive	06	Goodrive20-EU Vector VFD

Note: The code is consisted of 16 bit which is high 8 bits and low 8 bits. High 8 bits mean the motor type series and low 8 bits mean the derived motor types of the series. For example, 0110H means Goodrive20-EU vector VFDs.

7.4.3 Fieldbus scale

The communication data is expressed by hex in actual application and there is no radix point in hex. For example, 50.12Hz cannot be expressed by hex so 50.12 can be magnified by 100 times into 5012, so hex 1394H can be used to express 50.12.

A non-integer can be timed by a multiple to get an integer and the integer can be called fieldbus ratio values.

The fieldbus ratio values are referred to the radix point of the setting range or default value in the function parameter list. If there are figures behind the radix point ($n=1$), then the fieldbus ratio value m is 10^n . Take the table as the example:

Function code	Name	Description	Default	Modify
P01.20	Wake-up-from-sleep delay	0.0–3600.0s (valid when P01.19 is 2)	0.0s	<input type="radio"/>
P01.21	Restart after power off	0: Disable 1: Enable	0	<input type="radio"/>

If there is one figure behind the radix point in the setting range or the default value, then the fieldbus ratio value is 10. If the data received by the upper monitor is 50, then the "hibernation restore delay time" is 5.0 ($5.0=50\div 10$).

If Modbus communication is used to control the hibernation restore delay time as 5.0s. Firstly, 5.0 can be magnified by 10 times to integer 50 (32H) and then this data can be sent.

01 **06** **01 14** **00 32** **49 E7**
 VFD Write Parameters Data number CRC check
 address command address

After the VFD receives the command, it will change 50 into 5 according to the fieldbus ratio value and then set the hibernation restore delay time as 5s.

Another example, after the upper monitor sends the command of reading the parameter of hibernation restore delay time, if the response message of the VFD is as following:

01 **03** **02** **00 32** **39 91**
 VFD Read 2-byte Parameters CRC check
 address command data data

Because the parameter data is 0032H (50) and 50 divided by 10 is 5, then the hibernation restore delay time is 5s.

7.4.4 Error message response

Operation errors may occur in communication-based control. For example, some parameters can only be read, but a write command is transmitted. In this case, the VFD returns an error

message response. Error message responses are sent from the VFD to the master. The following table describes the codes and definitions of the error message responses.

Code	Name	Meaning
01H	Invalid command	The command code received by the upper computer is not allowed to be executed. The possible causes are as follows: <ul style="list-style-type: none"> • The function code is applicable only on new devices and is not implemented on this device. • The slave is in the faulty state when processing this request.
02H	Invalid data address.	For the VFD, the data address in the request of the upper computer is not allowed. In particular, the combination of the register address and the number of the to-be-transmitted bytes is invalid.
03H	Invalid data value	The received data domain contains a value that is not allowed. The value indicates the error of the remaining structure in the combined request. Note: It does not mean that the data item submitted for storage in the register includes a value unexpected by the program.
04H	Operation failure	The parameter is set to an invalid value in the write operation. For example, a function input terminal cannot be set repeatedly.
05H	Password error	The password entered in the password verification address is different from that set in P07.00.
06H	Data frame error	The length of the data frame transmitted by the upper computer is incorrect, or in the RTU format, the value of the CRC check bit is inconsistent with the CRC value calculated by the lower computer.
07H	Parameter read-only	The parameter to be modified in the write operation of the upper computer is a read-only parameter.
08H	Parameter cannot be modified in running	The parameter to be modified in the write operation of the upper computer cannot be modified during the running of the VFD.
09H	Password protection	A user password is set, and the upper computer does not provide the password to unlock the system when performing a read or write operation. The error of "system locked" is reported.

The slave uses functional code fields and fault addresses to indicate it is a normal response or some error occurs (named as objection response). For normal responses, the slave shows corresponding function codes, digital address or sub-function codes as the response. For objection responses, the slave returns a code which equals the normal code, but the first byte is logic 1.

For example: when the master sends a message to the slave, requiring it to read a group of address data of the VFD function codes, there will be following function codes:

0 0 0 0 0 1 1 (Hex 03H)

For normal responses, the slave responds the same codes, while for objection responses, it will return:

1 0 0 0 0 1 1 (Hex 83H)

Besides the function codes modification for the objection fault, the slave will respond a byte of abnormal code which defines the error reason.

When the master receives the response for the objection, in a typical processing, it will send the message again or modify the corresponding order.

For example, set the "running command channel" of the VFD (P00.01, parameter address is 0001H) with the address of 01H to 03, the command is as following:

<u>01</u>	<u>06</u>	<u>00 01</u>	<u>00 03</u>	<u>98 0B</u>
VFD address	Write command	Parameters address	Parameters data	CRC check

But the setting range of "running command channel" is 0–2, if it is set to 3, because the number is beyond the range, the VFD will return fault response message as below:

<u>01</u>	<u>86</u>	<u>04</u>	<u>43 A3</u>
VFD address	Abnormal response code	Fault code	CRC check

Abnormal response code 86H means the abnormal response to writing command 06H; the fault code is 04H. In the table above, its name is operation failed and its meaning is that the parameter setting in parameter writing is invalid. For example, the function input terminal cannot be set repeatedly.

7.5 Read/Write operation example

7.5.1 Examples of reading command 03H

Example 1: Read the state word 1 of the VFD whose address is 01H (see section 7.4.2 "Description of other function addresses in Modbus"). The parameter address of the state word 1 of the VFD is 2100H.

RTU mode:

The command sent to the VFD:

<u>01</u>	<u>03</u>	<u>21 00</u>	<u>00 01</u>	<u>8E 36</u>
VFD address	Read command	Parameters address	Data number	CRC check

If the operation succeeds, the response message is as follows:

<u>01</u>	<u>03</u>	<u>02</u>	<u>00 03</u>	<u>F8 45</u>
VFD address	Read command	Data address	Data content	CRC check

ASCII mode:

The command sent to the VFD:

:	<u>01</u>	<u>03</u>	<u>21 00</u>	<u>00 01</u>	<u>DA</u>	<u>CR LF</u>
START	VFD address	Read command	Parameters address	Data number	LRC check	END

If the operation succeeds, the response message is as follows:

:	<u>01</u>	<u>03</u>	<u>02</u>	<u>00 03</u>	<u>F7</u>	<u>CR LF</u>
START	VFD address	Read command	Byte number	Data content	LRC check	END

The data content is 0003H. According to the parameter table of other functions, the VFD stops.

7.5.2 Examples of write command 06H

Example 1: Set the VFD whose address is 03H to be forward running. See section 7.4.2 "Description of other function addresses in Modbus", the address of "Communication-based control command" is 2000H, and 0001H indicates forward running.

Function	Address	Data description	R/W characteristics
Communication-based control command	2000H	0001H: Forward running	R/W
		0002H: Reverse running	
		0003H: Forward jogging	
		0004H: Reverse jogging	
		0005H: Stop	
		0006H: Coast to stop (emergency stop)	
		0007H: Fault reset	
		0008H: Jogging stop	

RTU mode:

The command sent by the master:

<u>03</u>	<u>06</u>	<u>20 00</u>	<u>00 01</u>	<u>42 28</u>
VFD address	Write command	Parameters address	Forward running	CRC check

If the operation is successful, the response may be as below (the same with the command sent by the master):

<u>03</u>	<u>06</u>	<u>20 00</u>	<u>00 01</u>	<u>42 28</u>
VFD address	Write command	Parameters address	Forward running	CRC check

ASCII mode:

The command sent to the VFD:

:	<u>01</u>	<u>06</u>	<u>20 00</u>	<u>00 01</u>	<u>D6</u>	<u>CR LF</u>
START	VFD address	Write command	Parameters address	Data number	LRC check	END

If the operation succeeds, the response message is as follows:

:	<u>01</u>	<u>06</u>	<u>20 00</u>	<u>00 01</u>	<u>D6</u>	<u>CR LF</u>
START	VFD address	Write command	Parameters address	Data number	LRC check	END

Example 2: Set the max. output frequency of the VFD with the address of 03H as 100Hz.

Function code	Name	Description	Default	Modify
P00.03	Max. output frequency	Used to set the max. output frequency of the VFD. It is the basis of frequency setup and the acceleration/deceleration. Setting range: P00.04–400.00Hz	50.00Hz	©

See the figures behind the radix point, the fieldbus ratio value of the max. output frequency (P00.03) is 100. 100Hz timed by 100 is 10000 and the corresponding hex is 2710H.

RTU mode:

The command sent by the master:

<u>03</u>	<u>06</u>	<u>00 03</u>	<u>27 10</u>	<u>62 14</u>
VFD address	Write command	Parameters address	Parameter data	CRC check

If the operation is successful, the response may be as below (the same with the command sent by the master):

<u>03</u>	<u>06</u>	<u>00 03</u>	<u>27 10</u>	<u>62 14</u>
VFD address	Write command	Parameters address	Parameter data	CRC check

ASCII mode:

The command sent to the VFD:

:	<u>03</u>	<u>06</u>	<u>00 03</u>	<u>27 10</u>	<u>BD</u>	<u>CR LF</u>
START	VFD address	Write command	Parameters address	Parameter data	LRC check	END

If the operation succeeds, the response message is as follows:

:	<u>03</u>	<u>06</u>	<u>00 03</u>	<u>27 10</u>	<u>BD</u>	<u>CR LF</u>
START	VFD address	Write command	Parameters address	Parameter data	LRC check	END

7.5.3 Examples of continuously writing command 10H

Example 1: Set the VFD whose address is 01H to be forward running at the frequency of 10Hz. See section 7.4.2 "Description of other function addresses in Modbus", the address of "Communication-based control command" is 2000H, and 0001H indicates forward running. The address of "Communication-based frequency setting" is 2001H and 10Hz corresponds to 03E8H. See the table below.

Function	Address	Data description	R/W characteristics
Communication-based control command	2000H	0001H: Forward running	R/W
		0002H: Reverse running	
		0003H: Forward jogging	
		0004H: Reverse jogging	
		0005H: Stop	
		0006H: Coast to stop (emergency stop)	
		0007H: Fault reset	
		0008H: Jogging stop	
The address of communication setting	2001H	Communication-based frequency setting (0–Fmax (unit: 0.01Hz))	R/W
	2002H	PID reference, range (0–1000, 1000 corresponds to 100.0%)	

RTU mode:

The command sent to the VFD:

01 10 20 00 00 02 04 00 01 03 E8 3B 10
 VFD Continuous Parameters Data Byte Forward 10Hz CRC check
 address writing address number number running

If the operation succeeds, the response message is as follows:

01 10 20 00 00 02 4A 08
 VFD Continuous Parameters Data CRC check
 address writing address number

ASCII mode:

The command sent to the VFD:

: 01 10 20 00 00 02 04 00 01 03 E8 BD CR LF
 START VFD Continuous Parameters Data Byte Forward 10Hz LRC END
 address writing address number number running check

If the operation succeeds, the response message is as follows:

: 01 10 20 00 00 02 CD CR LF
 START VFD Continuous Parameters Data LRC END
 address writing address number check

Example 2: set the ACC time of 01H VFD as 10s and the DEC time as 20s

P00.11	ACC time 1	Setting range of P00.11 and P00.12:	Depend on model	<input type="radio"/>
P00.12	DEC time 1	0.0~3600.0s	Depend on model	<input type="radio"/>

The corresponding address of P00.11 is 000B, the ACC time of 10s corresponds to 0064H, and the DEC time of 20s corresponds to 00C8H.

RTU mode:

The command sent to the VFD:

01 10 00 0B 00 02 04 00 64 00 C8 F2 55
 VFD Continuous Parameters Data Byte 10s 20s CRC check
 address writing address number number

If the operation succeeds, the response message is as follows:

01 10 00 0B 00 02 30 0A
 VFD Continuous Parameters Data CRC check
 address writing address number

ASCII mode:

The command sent to the VFD:

:	<u>01</u>	<u>10</u>	<u>00 0B</u>	<u>00 02</u>	<u>04</u>	<u>00 64</u>	<u>00 C8</u>	<u>B2</u>	<u>CR LF</u>
START	VFD address	Continuous writing command	Parameters address	Data number	Number of bytes	10s	20s	LRC check	END

If the operation succeeds, the response message is as follows:

:	<u>01</u>	<u>10</u>	<u>00 0B</u>	<u>00 02</u>	<u>E2</u>	<u>CR LF</u>
START	VFD address	Continuous writing command	Parameters address	Data number	LRC check	END

Note: The blank in the above command is for illustration. The blank cannot be added in the actual application unless the upper monitor can remove the blank by themselves.

7.6 Common communication faults

Common communication faults include the following:

- ✧ No response is returned.
- ✧ The VFD returns an exception response.

Possible causes of no response include the following:

- ✧ The serial port is set incorrectly. For example, the converter uses the serial port COM1, but COM2 is selected for the communication.
- ✧ The settings of the baud rates, data bits, stop bits, and check bits are inconsistent with those set on the VFD.
- ✧ The positive pole (+) and negative pole (-) of the RS485 bus are connected reversely.
- ✧ The RS485 wire cap on the terminal board of the VFD is not connected. This wire cap is at the back of the terminal block.

Appendix A Technical data

A.1 Derated application

A.1.1 Capacity

VFD sizing is based on the rated motor current and power. To achieve the rated motor power given in the table, the rated current of the VFD must be higher than or equal to the rated motor current. Also the rated power of the VFD must be higher than or equal to the rated motor power. The power ratings are the same regardless of the supply voltage within one voltage range.

Note:

- ◇ The maximum allowable shaft power of the motor is limited to 1.5 times the rated power of the motor. If the limit is exceeded, the VFD automatically restricts the torque and current of the motor. This function effectively protects the input shaft against overload.
- ◇ The rated capacity is the capacity at the ambient temperature of 40°C.
- ◇ You need to check and ensure that the power flowing through the common DC connection in the common DC system does not exceed the rated power of the motor.

A.1.2 Derating

The load capacity decreases if the installation site ambient temperature exceeds 40°C, the altitude exceeds 1000 meters or the switching frequency is changed from 4 kHz to 8, 12 or 15 kHz.

A.1.2.1 Derating due to temperature

When the temperature ranges from +40°C to +50°C, the rated output current is derated by 1% for each increased 1°C. For the actual derating, see the following figure.

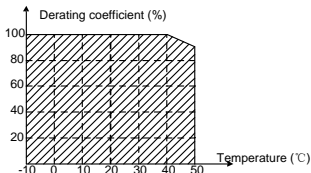

A.1.2.2 Derating due to altitude

When the altitude of the site where the VFD is installed is lower than 1000m, the VFD can run at the rated power. When the altitude exceeds 1000m, derate by 1% for every increase of 100m. When the altitude exceeds 3000m, consult the local INVT dealer or office for details.

A.1.3 Power consumption

Input voltage	Output power	Input current (A)	Output current (A)	Power consumption (full load)	Power consumption (30% rated load)	Ventilation (CFM)	Ventilation (m³/h)
1PH 230V	0.4kW	6.5	2.5	28.57W	14.69W	2.7	4.59
	0.75kW	9.3	4.2	42.62W	16.71W		
	1.5kW	15.7	7.5	81.68W	28.19W	10.9	18.53
	2.2kW	24	10	128.32W	32.27W		
3PH 230V	0.4kW	3.7	2.5	45.83W	17.02W	12.5	21.25
	0.75kW	5	4.2	69.84W	25.04W		
	1.5kW	7.7	7.5	113.89W	39.55W		
	2.2kW	11	10	145.35W	46.38W	55	93.5
	4kW	17	16	229.72W	60.99W		
	5.5kW	21	20	238.17W	71.60W		
7.5kW	31	30	354.13W	104.03W			
3PH 400V	0.75kW	3.4	2.5	49.56W	22.16W	10.9	18.53
	1.5kW	5	4.2	76.23W	28.79W		
	2.2kW	5.8	5.5	91.24W	32.9W		
	4kW	13.5	9.5	195.36W	56.54W	12.5	21.25
	5.5kW	19.5	14	306.9W	75.34W		
	7.5kW	25	18.5	297.68W	84.07W		
	11kW	32	25	438.38W	130.54W	55	93.5
	15kW	40	32	406.3W	108.69W		
	18.5kW	47	38	530.01W	135.35W		
	22kW	51	45	886.36W	262.82W	81	137.7
	30kW	70	60	882.25W	226.75W		
	37kW	80	75	980.79W	260.2W	79	134.3
45kW	98	92	1127.34W	311.53W			

Input voltage	Output power	Input current (A)	Output current (A)	Power consumption (full load)	Power consumption (30% rated load)	Ventilation (CFM)	Ventilation (m ³ /h)
	55kW	128	115	1441.22W	381.67W		
	75kW	160	150	1916.38W	478.55W		
	90kW	190	180	2272.04W	587.66W	250	425
	110kW	225	215	2735.7W	650.93W		

A.2 CE

A.2.1 CE marking

The CE mark is attached to the drive to verify that the drive follows the provisions of the European Low Voltage (2014/35/EU) and EMC Directives (2014/30/EU).

A.2.2 Compliance with the European EMC Directive

The EMC Directive defines the requirements for immunity and emissions of electrical equipment used within the European Union. The EMC product standard (EN 61800-3) covers requirements stated for drives. See section A.3 "EMC regulations".

A.3 EMC regulations

The EMC product standard (EN 61800-3) describes the EMC requirements to the VFD.

First environment: domestic environment (includes establishments connected to a low-voltage network which supplies buildings used for domestic purposes).

Second environment includes establishments connected to a network not directly supplying domestic premises.

Four categories of the VFD:

VFD of category C1: VFD of rated voltage less than 1000 V and used in the first environment.

VFD of category C2: VFD of rated voltage less than 1000 V other than pins, sockets and motion devices and intended to be installed and commissioned only by a professional electrician when used in the first environment.

Note: IEC/EN 61800-3 in EMC standard doesn't limit the power distribution of the VFD, but it defines the upstage, installation and commission. The professional electrician has necessary skills in installing and/or commissioning power drive systems, including their EMC aspects.

VFD of category C3: VFD of rated voltage less than 1000 V and used in the second environment other than the first one.

VFD of category C4: VFD of rated voltage more than 1000 V or the nominal current is above or

equal to 400A and used in the complicated system in second environment.

A.3.1 VFDs of category C2

The induction disturbance limit meets the following stipulations:

1. Select an optional EMC filter according to Appendix C "Optional peripheral accessories" and install it following the description in the EMC filter manual.
2. Select the motor and control cables according to the description in the manual.
3. Install the VFD according to the description in the manual.



⚡ In a domestic environment, this product may cause radio interference, in which case supplementary mitigation measures may be required.

A.3.2 VFDs of category C3

The anti-interference performance of the VFD meets the requirements of environments Category II in the IEC/EN 61800-3 standard.

The induction disturbance limit meets the following stipulations:

1. Select an optional EMC filter according to Appendix C "Optional peripheral accessories" and install it following the description in the EMC filter manual.
2. Select the motor and control cables according to the description in the manual.
3. Install the VFD according to the description in the manual.



⚡ VFDs of C3 category cannot be applied to civilian low-voltage common grids. When applied to such grids, the VFDs may generate radio frequency electromagnetic interference.

A.4 Motor connection data

Motor type	Asynchronous induction motor
Voltage	0–U ₁ (rated voltage of the motor), 3PH symmetrical, U _{max} (rated voltage of the VFD) at the field-weakening point
Short-circuit protection	The short-circuit protection for the motor output meets the requirements of IEC 61800-5-1. According to the definition in IEC 61439-1, the maximum allowable short-circuit current at the incoming end is 100 kA. Therefore, the VFD is applicable to applications where the transmitted current in the circuit is no larger than 100 kA, when it runs at the maximum rated voltage.
Frequency	0–400 Hz

Frequency resolution	0.01 Hz
Current	See the rated current.
Power limit	1.5 times of the rated power of the motor
Field-weakening point	10–400 Hz
Carrier frequency	2, 4 or 8kHz

Appendix B Dimension drawings

Dimension drawings of the Goodrive20-EU are shown as follows. The dimensions are given in mm.

B.1 External keypad structure

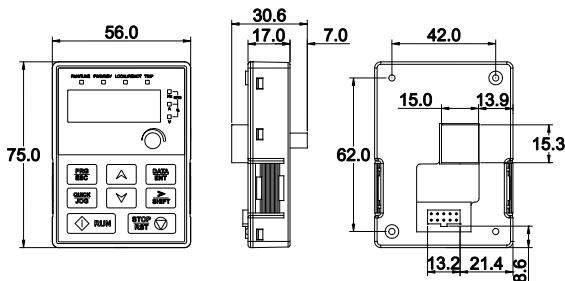

Figure B-1 Keypad dimensions

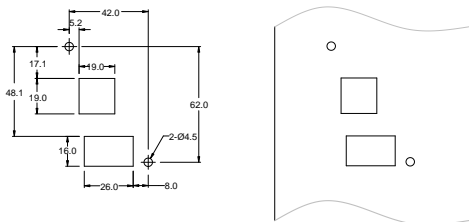

Figure B-2 Hole-cutting diagram for non-bracket keypad

Note: An external keypad is the optional part for the VFD models of 1PH 230V/3PH 400V ($\leq 2.2\text{kW}$) and 3PH 230V ($\leq 0.75\text{kW}$). For the VFD models of 3PH 400V ($\geq 4\text{kW}$) and 3PH 230V ($\geq 1.5\text{kW}$), the keypad can be connected externally.

When connecting the keypad externally, you can install it on the keypad adapter bracket. There are two types of keypad adapter brackets, which are commonly used with the keypad. The keypad adapter brackets are optional parts, and their outline and installation dimensions are shown in Figure B-3.

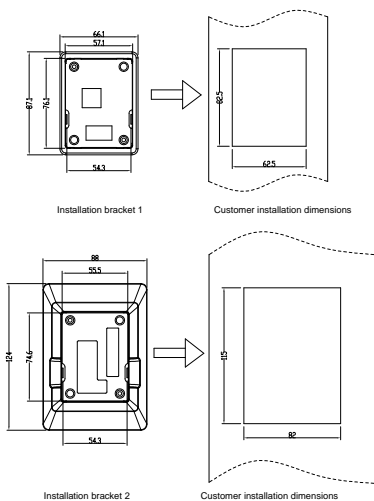

Figure B-3 Outline and installation dimensions

B.2 VFD chart

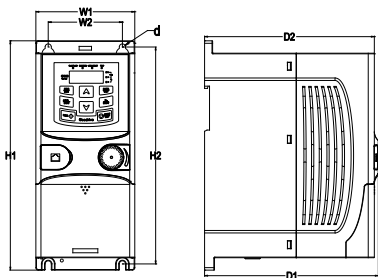

Figure B-4 Wall mounting of 0.75–2.2kW VFDs (Dimension unit: mm)

Model	W1	W2	H1	H2	D1	D2	Mounting hole diameter (d)	Weight (kg)
GD20-0R4G-S2-EU	80.0	60.0	160.0	150.0	123.5	120.3	∅ 5	0.9
GD20-0R7G-S2-EU	80.0	60.0	160.0	150.0	123.5	120.3	∅ 5	0.9
GD20-1R5G-S2-EU	80.0	60.0	185.0	175.0	140.5	137.3	∅ 5	1.2
GD20-2R2G-S2-EU	80.0	60.0	185.0	175.0	140.5	137.3	∅ 5	1.2
GD20-0R4G-2-EU	80.0	60.0	185.0	175.0	140.5	137.3	∅ 5	1
GD20-0R7G-2-EU	80.0	60.0	185.0	175.0	140.5	137.3	∅ 5	1
GD20-0R7G-4-EU	80.0	60.0	185.0	175.0	140.5	137.3	∅ 5	1
GD20-1R5G-4-EU	80.0	60.0	185.0	175.0	140.5	137.3	∅ 5	1
GD20-2R2G-4-EU	80.0	60.0	185.0	175.0	140.5	137.3	∅ 5	1

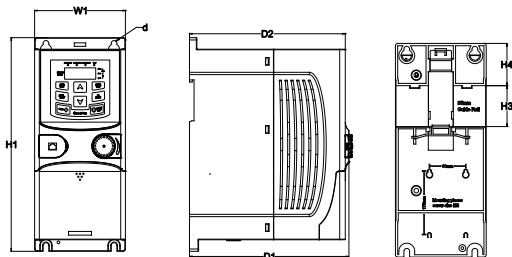

Figure B-5 Rail mounting of VFDs of 1PH 220V/3PH 380V ($\leq 2.2\text{kW}$) and 3PH 220V ($\leq 0.75\text{kW}$)
(Dimension (unit: mm))

Model	W1	H1	H3	H4	D1	D2	Mounting hole diameter (d)	Weight (kg)
GD20-0R4G-S2-EU	80.0	160.0	35.4	36.6	123.5	120.3	∅ 5	0.9
GD20-0R7G-S2-EU	80.0	160.0	35.4	36.6	123.5	120.3	∅ 5	0.9
GD20-1R5G-S2-EU	80.0	185.0	35.4	36.6	140.5	137.3	∅ 5	1.2
GD20-2R2G-S2-EU	80.0	185.0	35.4	36.6	140.5	137.3	∅ 5	1.2
GD20-0R4G-2-EU	80.0	185.0	35.4	36.6	140.5	137.3	∅ 5	1
GD20-0R7G-2-EU	80.0	185.0	35.4	36.6	140.5	137.3	∅ 5	1
GD20-0R7G-4-EU	80.0	185.0	35.4	36.6	140.5	137.3	∅ 5	1
GD20-1R5G-4-EU	80.0	185.0	35.4	36.6	140.5	137.3	∅ 5	1
GD20-2R2G-4-EU	80.0	185.0	35.4	36.6	140.5	137.3	∅ 5	1

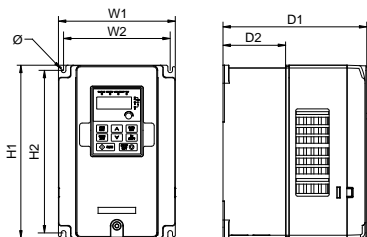

Figure B-6 Wall mounting of 3PH 400V 4–37kW and 3PH 230V 1.5–7.5kW VFDs

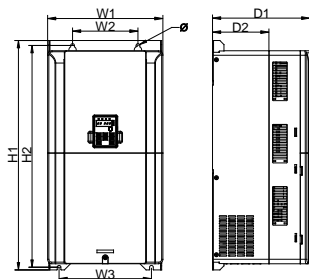

Figure B-7 Wall mounting of 3PH 400V 45–75kW VFDs

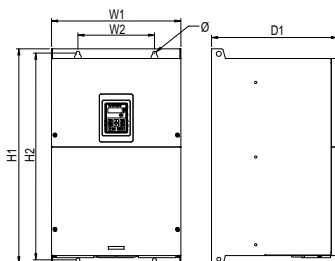

Figure B-8 Wall mounting of 3PH 400V 90–110kW VFDs (Dimension (unit: mm))

Model	W1	W2	W3	H1	H2	D1	D2	Mounting hole diameter (d)	Weight (kg)
GD20-1R5G-2-EU	146.0	131.0	—	256.0	243.5	167.0	84.5	Ø 6	3.1
GD20-2R2G-2-EU	146.0	131.0	—	256.0	243.5	167.0	84.5	Ø 6	3.1
GD20-004G-2-EU	146.0	131.0	—	256.0	243.5	167.0	84.5	Ø 6	3.1
GD20-5R5G-2-EU	170.0	151.0	—	320.0	303.5	196.3	113.0	Ø 6	5.58
GD20-7R5G-2-EU	170.0	151.0	—	320.0	303.5	196.3	113.0	Ø 6	5.83
GD20-004G-4-EU	146.0	131.0	—	256.0	243.5	167.0	84.5	Ø 6	3.1
GD20-5R5G-4-EU	146.0	131.0	—	256.0	243.5	167.0	84.5	Ø 6	3.1
GD20-7R5G-4-EU	170.0	151.0	—	320.0	303.5	196.3	113.0	Ø 6	5.58
GD20-011G-4-EU	170.0	151.0	—	320.0	303.5	196.3	113.0	Ø 6	5.58
GD20-015G-4-EU	170.0	151.0	—	320.0	303.5	196.3	113.0	Ø 6	5.83
GD20-018G-4-EU	200.0	185.0	—	340.6	328.6	184.3	104.5	Ø 6	9
GD20-022G-4-EU	200.0	185.0	—	340.6	328.6	184.3	104.5	Ø 6	9
GD20-030G-4-EU	250.0	230.0	—	400.0	380.0	202.0	123.5	Ø 6	15.5
GD20-037G-4-EU	250.0	230.0	—	400.0	380.0	202.0	123.5	Ø 6	15.5
GD20-045G-4-EU	282.0	160.0	226.0	560.0	542.0	238.0	138.0	Ø 9	25
GD20-055G-4-EU	282.0	160.0	226.0	560.0	542.0	238.0	138.0	Ø 9	25
GD20-075G-4-EU	282.0	160.0	226.0	560.0	542.0	238.0	138.0	Ø 9	25
GD20-090G-4-EU	338.0	200.0	—	554.0	535.0	329.2	—	Ø 9.5	45
GD20-110G-4-EU	338.0	200.0	—	554.0	535.0	329.2	—	Ø 9.5	45

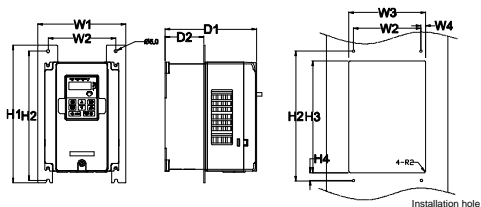

Figure B-9 Flange mounting of 3PH 400V 4–75kW and 3PH 230V 1.5–7.5kW VFDs

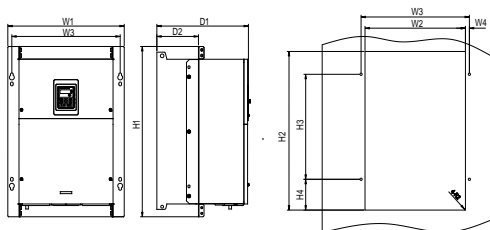

Figure B-10 Flange mounting of 3PH 400V 90–110kW VFDs (Dimension (unit: mm))

Model	W1	W2	W3	W4	H1	H2	H3	H4	D1	D2	Mounting hole diameter (d)	Screw	Weight (kg)
GD20-1R5G-2-EU	170.2	131	150	9.5	292	276	260	6	167	84.5	Ø 6	M5	3.1
GD20-2R2G-2-EU	170.2	131	150	9.5	292	276	260	6	167	84.5	Ø 6	M5	3.1
GD20-004G-2-EU	170.2	131	150	9.5	292	276	260	6	167	84.5	Ø 6	M5	3.1
GD20-5R5G-2-EU	191.2	151	174	11.5	370	351	324	12	196.3	113	Ø 6	M5	5.58
GD20-7R5G-2-EU	191.2	151	174	11.5	370	351	324	12	196.3	113	Ø 6	M5	5.83
GD20-004G-4-EU	170.2	131	150	9.5	292	276	260	6	167	84.5	Ø 6	M5	3.1
GD20-5R5G-4-EU	170.2	131	150	9.5	292	276	260	6	167	84.5	Ø 6	M5	3.1
GD20-7R5G-4-EU	191.2	151	174	11.5	370	351	324	12	196.3	113	Ø 6	M5	5.58
GD20-011G-4-EU	191.2	151	174	11.5	370	351	324	12	196.3	113	Ø 6	M5	5.58
GD20-015G-4-EU	191.2	151	174	11.5	370	351	324	12	196.3	113	Ø 6	M5	5.83
GD20-018G-4-EU	266	250	224	13	371	250	350.6	20.3	184.6	104	Ø 6	M5	9
GD20-022G-4-EU	266	250	224	13	371	250	350.6	20.3	184.6	104	Ø 6	M5	9
GD20-030G-4-EU	316	300	274	13	430	300	410	55	202	118.3	Ø 6	M5	15.5
GD20-037G-4-EU	316	300	274	13	430	300	410	55	202	118.3	Ø 6	M5	15.5
GD20-045G-4-EU	352	332	306	13	580	400	570	80	238	133.8	Ø 9	M8	25
GD20-055G-4-EU	352	332	306	13	580	400	570	80	238	133.8	Ø 9	M8	25
GD20-075G-4-EU	352	332	306	13	580	400	570	80	238	133.8	Ø 9	M8	25
GD20-090G-4-EU	418.5	361	389.5	14.2	600	559	370	108.5	329.5	149.5	Ø 9.5	M8	45
GD20-110G-4-EU	418.5	361	389.5	14.2	600	559	370	108.5	329.5	149.5	Ø 9.5	M8	45

Note: An optional flange installation bracket is required for flange installation.

Appendix C Optional peripheral accessories







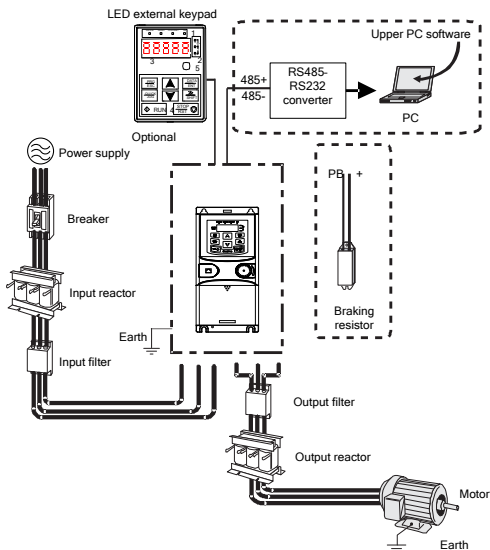

This chapter describes how to select the options and parts of Goodrive20-EU series.

C.1 Wiring of peripheral accessories

The following figure shows the external wiring of the VFD.



Pictures	Name	Descriptions
	External keypad	<p>External keypads include the external keypads with and without the function of parameter copying.</p> <p>When the external keypad with parameter copying is valid, the local keypad is off; when the external keypad without parameter copying is valid, the local and external keypads are on simultaneously.</p>

Pictures	Name	Descriptions
	Cable	Accessory for signal transmission.
	Breaker	Device for electric shock prevention and protection against short-to-ground that may cause current leakage and fire. Select residual-current circuit breakers (RCCBs) that are applicable to VFDs and can restrict high-order harmonics, and of which the rated sensitive current for one VFD is larger than 30 mA.
	Input reactor	Accessories used to improve the current adjustment coefficient on the input side of the VFD, and thus restrict high-order harmonic currents.
	Input filter	Accessory that restricts the electromagnetic interference generated by the VFD and transmitted to the public grid through the power cable. Try to install the input filter near the input terminal side of the VFD.
	Braking resistors	Accessories used to consume the regenerative energy of the motor to reduce the DEC time. The VFD models need only to be configured with braking resistors.
	Output filter	Accessory used to restrict interference generated in the wiring area on the output side of the VFD. Try to install the output filter near the output terminal side of the VFD.
	Output reactor	Accessory used to lengthen the valid transmission distance of the VFD, which effectively restrict the transient high voltage generated during the switch-on and switch-off of the IGBT module of the VFD.
	Membrane of heat releasing holes at the side	Accessory applied in severe environment scenarios for improving protective effect. The VFD can be derated by 10% through using the membrane.

C.2 Power supply

	⚡ Ensure that the voltage class of the VFD is consistent with that of the grid.
--	---

C.3 Cables

C.3.1 Power cables

The sizes of the input power cables and motor cables must meet the local regulation.

Note: If the conductivity of the shielding layer of the motor cables cannot meet the requirements, separate PE conductors must be used.

C.3.2 Control cables

All analog control cables and cables used for frequency input must be shielded cables.

Relay cables need to be those with metal braided shield layers.

Note:

- ◇ Analog signals and digital signals cannot use the same cables, and their cables must be arranged separately.
- ◇ Check the insulation conditions of the input power cable of a VFD according to the local regulations before connecting it.

Model	Recommended cable size (mm ²)		Size of connectable cable (mm ²)			Terminal screw	Tightening torque (Nm)
	RST	PE	RST	P1, (+)	PE		
	UVW		UVW				
GD20-0R4G-S2-EU	1.5	1.5	1-4	1-4	1-4	M3	0.5
GD20-0R7G-S2-EU	1.5	1.5	1-4	1-4	1-4	M3	0.5
GD20-1R5G-S2-EU	2.5	2.5	1-4	1-4	1-4	M3	0.5
GD20-2R2G-S2-EU	2.5	2.5	1-4	1-4	1-4	M3	0.5
GD20-0R4G-2-EU	1.5	1.5	1-1.5	1-1.5	1-1.5	M3	0.8
GD20-0R7G-2-EU	1.5	1.5	1-1.5	1-1.5	1-1.5	M3	0.8
GD20-1R5G-2-EU	2.5	2.5	1.5-6	2.5-6	2.5-6	M4	1.13
GD20-2R2G-2-EU	2.5	2.5	1.5-6	2.5-6	2.5-6	M4	1.13
GD20-004G-2-EU	2.5	2.5	1.5-6	2.5-6	2.5-6	M4	1.13
GD20-5R5G-2-EU	4	4	4-10	4-10	4-10	M5	2.3
GD20-7R5G-2-EU	6	6	4-10	4-10	4-10	M5	2.3
GD20-0R7G-4-EU	1.5	1.5	1-1.5	1-1.5	1-1.5	M3	0.8
GD20-1R5G-4-EU	1.5	1.5	1-1.5	1-1.5	1-1.5	M3	0.8
GD20-2R2G-4-EU	1.5	1.5	1-1.5	1-1.5	1-1.5	M3	0.8
GD20-004G-4-EU	2.5	2.5	2.5-6	2.5-6	2.5-6	M4	1.13
GD20-5R5G-4-EU	2.5	2.5	2.5-6	2.5-6	2.5-6	M4	1.13
GD20-7R5G-4-EU	4	4	4-10	4-10	4-10	M5	2.3
GD20-011G-4-EU	6	6	4-10	4-10	4-10	M5	2.3
GD20-015G-4-EU	6	6	4-10	4-10	4-10	M5	2.3

Model	Recommended cable size (mm ²)		Size of connectable cable (mm ²)			Terminal screw	Tightening torque (Nm)
	RST	PE	RST	P1, (+)	PE		
	UVW		UVW				
GD20-018G-4-EU	10	10	10-16	10-16	10-16	M5	2.3
GD20-022G-4-EU	16	16	10-16	10-16	10-16	M5	2.3
GD20-030G-4-EU	25	16	25-50	25-50	16-25	M6	2.5
GD20-037G-4-EU	25	16	25-50	25-50	16-25	M6	2.5
GD20-045G-4-EU	35	16	35-70	35-70	16-35	M8	10
GD20-055G-4-EU	50	25	35-70	35-70	16-35	M8	10
GD20-075G-4-EU	70	35	35-70	35-70	16-35	M8	10
GD20-090G-4-EU	95	50	70-120	70-120	50-70	M12	35
GD20-110G-4-EU	120	70	70-120	70-120	50-70	M12	35

Note:

- ◇ Cables of the sizes recommended for the main circuit can be used in scenarios where the ambient temperature is lower than 40°C, the wiring distance is shorter than 100 m, and the current is the rated current.
- ◇ Terminals P1, (+), PB and (-) are used to connect to the DC reactor options and parts.
- ◇ Take GD20-0R4G-S2-EU as an example, the tightening torque is 0.5Nm=5.1kgf.cm=4.43lb.in.

C.4 Breaker and electromagnetic contactor

The circuit breaker is mainly used to prevent electric shock accidents and short circuits to the ground that may cause leakage current fire. The electromagnetic contactor is mainly used to control the main circuit power on and off, which can effectively cut off the input power of the VFD in case of system failure to ensure safety.



- ◇ According to the working principle and structure of breakers, if the manufacturer's regulation is not followed, hot ionized gases may escape from the breaker enclosure when a short circuit occurs. To ensure safe use, exercise extra caution when installing and placing the breaker. Follow the manufacturer's instructions.

Model	Fuse (A)	Breaker (A)	Contactor rated current (A)
GD20-0R4G-S2-EU	10	10	9
GD20-0R7G-S2-EU	16	16	12
GD20-1R5G-S2-EU	25	25	25

Model	Fuse (A)	Breaker (A)	Contactora rated current (A)
GD20-2R2G-S2-EU	50	40	32
GD20-0R4G-2-EU	6	6	9
GD20-0R7G-2-EU	10	10	9
GD20-1R5G-2-EU	16	16	12
GD20-2R2G-2-EU	25	25	18
GD20-004G-2-EU	35	32	25
GD20-5R5G-2-EU	35	32	32
GD20-7R5G-2-EU	50	63	50
GD20-0R7G-4-EU	6	6	9
GD20-1R5G-4-EU	10	10	9
GD20-2R2G-4-EU	10	10	9
GD20-004G-4-EU	25	25	25
GD20-5R5G-4-EU	35	32	25
GD20-7R5G-4-EU	50	40	38
GD20-011G-4-EU	63	63	50
GD20-015G-4-EU	63	63	50
GD20-018G-4-EU	100	100	65
GD20-022G-4-EU	100	100	80
GD20-030G-4-EU	125	125	95
GD20-037G-4-EU	150	160	115
GD20-045G-4-EU	150	200	170
GD20-055G-4-EU	200	200	170
GD20-075G-4-EU	250	250	205
GD20-090G-4-EU	325	315	245
GD20-110G-4-EU	350	350	300

C.5 Reactors

Transient high current in the input power circuit may cause damage to the rectifying components. It is appropriate to use AC reactor in the input side for the avoidance of high-voltage input of the power supply and improvement of the power factors.

When the distance between the VFD and motor is longer than 50 m, the parasitic capacitance between the long cable and ground may cause large leakage current, and overcurrent protection of the VFD may be frequently triggered. To prevent this from happening and avoid damage to the motor insulator, compensation must be made by adding an output reactor. When a VFD is used to drive multiple motors, take the total length of the motor cables (that is, sum of the lengths of the motor cables) into account. When the total length is longer than 50 m, an output reactor must be added on the output side of the VFD. If the distance between the

VFD and motor is 50 m to 150 m, select the reactor according to the following table. If the distance is longer than 150 m, contact INVT's technical support technicians.

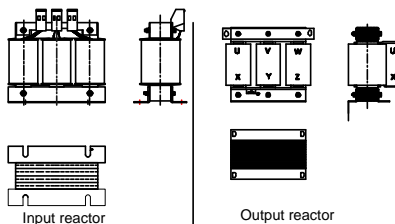

Model	Input reactor	Output reactor
GD20-0R4G-S2-EU		
GD20-0R7G-S2-EU		
GD20-1R5G-S2-EU		
GD20-2R2G-S2-EU		
GD20-0R4G-2-EU	ACL2-1R5-4	OCL2-1R5-4
GD20-0R7G-2-EU	ACL2-1R5-4	OCL2-1R5-4
GD20-1R5G-2-EU	ACL2-004-4	OCL2-004-4
GD20-2R2G-2-EU	ACL2-004-4	OCL2-004-4
GD20-004G-2-EU	ACL2-5R5-4	OCL2-5R5-4
GD20-5R5G-2-EU	ACL2-7R5-4	OCL2-7R5-4
GD20-7R5G-2-EU	ACL2-015-4	OCL2-015-4
GD20-0R7G-4-EU	ACL2-1R5-4	OCL2-1R5-4
GD20-1R5G-4-EU	ACL2-1R5-4	OCL2-1R5-4
GD20-2R2G-4-EU	ACL2-2R2-4	OCL2-2R2-4
GD20-004G-4-EU	ACL2-004-4	OCL2-004-4
GD20-5R5G-4-EU	ACL2-5R5-4	OCL2-5R5-4
GD20-7R5G-4-EU	ACL2-7R5-4	OCL2-7R5-4
GD20-011G-4-EU	ACL2-011-4	OCL2-011-4
GD20-015G-4-EU	ACL2-015-4	OCL2-015-4
GD20-018G-4-EU	ACL2-018-4	OCL2-018-4
GD20-022G-4-EU	ACL2-022-4	OCL2-022-4
GD20-030G-4-EU	ACL2-037-4	OCL2-037-4
GD20-037G-4-EU	ACL2-037-4	OCL2-037-4
GD20-045G-4-EU	ACL2-045-4	OCL2-045-4
GD20-055G-4-EU	ACL2-055-4	OCL2-055-4
GD20-075G-4-EU	ACL2-075-4	OCL2-075-4

Model	Input reactor	Output reactor
GD20-090G-4-EU	ACL2-110-4	OCL2-110-4
GD20-110G-4-EU	ACL2-110-4	OCL2-110-4

Note:

- ◇ The rated input voltage drop of input reactors is 2%±15% while the rated output voltage drop of output reactors is 1%±15%.
- ◇ The preceding table describes external accessories. You need to specify the ones you choose when purchasing accessories.

C.6 Filter**C.6.1 C3 Filter model instruction**

FLT-P04003L-C-G

A
B
C
D
E
F
G

Field identifier	Field description
A	FLT: Name of the VFD filter series
B	Filter type P: Power input filter L: Output filter
C	Voltage class S2: AC 1PH 200V–240V 04: AC 3PH 380V–480V
D	3-digit development serial number. For example, 003 stands for the serial number of C3 filters in development
E	Filter performance L: General H: High-performance
F	Filter application environment A: Environment Category I (IEC61800-3) category C1 (EN 61800-3) B: Environment Category I (IEC61800-3) category C2 (EN 61800-3) C: Environment Category II (IEC61800-3) category C3 (EN 61800-3)
G	Lot No. G: Special for external C3 filter

C.6.2 C3 filter

Goodrive20-EU series 1PH 220V/3PH 380V 2.2kW and below, 3PH 220V 0.75kW and below models can satisfy the requirements of IEC61800-3 C3 as shown in the table below; 3PH 380V 4kW and above, 3PH 220V 1.5kW and above models can be set to satisfy the requirements of IEC61800-3 C3 or not by jumper J10.

Note: Disconnect J10 when either of below situations occurs:

1. EMC filter is suitable for the neutral-grounding grid system. If it is used in IT grid system (neutral point is not grounded), disconnect J10.
2. During configuring residual current circuit-breaker, if tripping occurred during startup, disconnect J10.

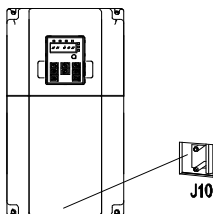

Interference filter on input side: As the VFD may interfere with peripheral devices during working, this filter can be used to reduce the interference.

Noise filter on output side: This filter can be used to reduce the radio noise caused between the VFD and motor as well as the leakage current of the lead wires.

Model	Input filter
GD20-0R4G-S2-EU	FLT-PS2004L-C-G
GD20-0R7G-S2-EU	
GD20-1R5G-S2-EU	
GD20-2R2G-S2-EU	
GD20-0R4G-2-EU	FLT-P04008L-C-G
GD20-0R7G-2-EU	
GD20-0R7G-4-EU	
GD20-1R5G-4-EU	
GD20-2R2G-4-EU	

Note:

- ◇ The input EMI meet the requirement of C3 after adding input filters.
- ◇ Above options are external, the customer should indicate when purchasing.

C.6.3 Installation instruction for C3 filter

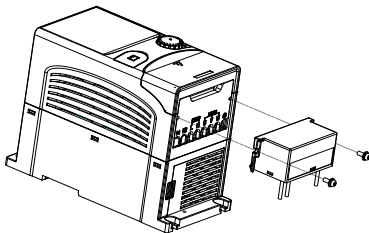

The installation procedures for C3 filter are as below:

1. Connect the filter cable to the corresponding input terminal of the VFD according to the label;
2. Fix the filter onto the VFD with M3*10 screws (as shown in above picture).

C.6.4 C2 Filter type instruction

FLT-P04016L-B
 A
 B
 C
 D
 E
 F

Field identifier	Field description
A	FLT: Name of the VFD filter series
B	Filter type P: Power input filter L: Output filter
C	Voltage class S2: AC 1PH 200V– 240V 04: AC 3PH 380V–480V
D	3-digit code indicating the rated current. For example, 016 indicates 16A.
E	Filter performance L: General H: High-performance
F	Filter application environment A: Environment Category I (IEC61800-3) category C1 (EN 61800-3) B: Environment Category I (IEC61800-3) category C2 (EN 61800-3)

C.6.5 C2 filter model selection

Model	Input filter	Output filter
GD20-0R4G-S2-EU	FLT-PS2010H-B	FLT-L04006L-B
GD20-0R7G-S2-EU		
GD20-1R5G-S2-EU	FLT-PS2025L-B	FLT-L04016L-B
GD20-2R2G-S2-EU		
GD20-0R4G-2-EU	FLT-P04006L-B	FLT-L04006L-B
GD20-0R7G-2-EU		
GD20-1R5G-2-EU	FLT-P04016L-B	FLT-L04016L-B
GD20-2R2G-2-EU		
GD20-004G-2-EU	FLT-P04032L-B	FLT-L04032L-B
GD20-5R5G-2-EU		
GD20-7R5G-2-EU	FLT-P04045L-B	FLT-L04045L-B
GD20-0R7G-4-EU	FLT-P04006L-B	FLT-L04006L-B
GD20-1R5G-4-EU		
GD20-2R2G-4-EU		
GD20-004G-4-EU	FLT-P04016L-B	FLT-L04016L-B
GD20-5R5G-4-EU		
GD20-7R5G-4-EU	FLT-P04032L-B	FLT-L04032L-B
GD20-011G-4-EU		
GD20-015G-4-EU	FLT-P04045L-B	FLT-L04045L-B
GD20-018G-4-EU		
GD20-022G-4-EU	FLT-P04065L-B	FLT-L04065L-B
GD20-030G-4-EU		
GD20-037G-4-EU	FLT-P04100L-B	FLT-L04100L-B
GD20-045G-4-EU		
GD20-055G-4-EU	FLT-P04150L-B	FLT-L04150L-B
GD20-075G-4-EU		
GD20-090G-4-EU	FLT-P04240L-B	FLT-L04240L-B
GD20-110G-4-EU		



Note:

- ◇ The input EMI meets the C2 requirements after an input filter is configured.
- ◇ The preceding table describes external accessories. You need to specify the ones you choose when purchasing accessories.

C.7 Braking resistors

C.7.1 Selecting braking resistors

It is appropriate to use braking resistor or braking unit when the motor brakes sharply or the motor is driven by a high inertia load. The motor will become a generator if its actual rotating speed is higher than the corresponding speed of the reference frequency. As a result, the inertial energy of the motor and load return to the VFD to charge the capacitors in the main DC circuit. When the voltage increases to the limit, damage may occur to the VFD. It is necessary to apply braking unit/resistor to avoid this accident happens.

	<ul style="list-style-type: none"> ✧ Only qualified electricians are allowed to design, install, commission and operate on the VFD. ✧ Follow the instructions in "warning" during working. Physical injury or death or serious property may occur. ✧ Only qualified electricians are allowed to wire. Damage to the VFD or brake options and part may occur. Read carefully the instructions of braking resistors or units before connecting them to the VFD. ✧ Do not connect the braking resistor to other terminals except for PB and (-). Do not connect the braking unit to other terminals except for (+) and (-). Damage to the VFD or braking circuit or fire may occur.
	<ul style="list-style-type: none"> ✧ Connect the braking resistor or braking unit to the VFD according to the diagram. Incorrect wiring may cause damage to the VFD or other devices.



Goodrive20-EU series VFDs have internal braking units.

Model	Type of braking unit	Braking resistor at 100% of braking torque (Ω)	Consumed power of the braking resistor (kW)			Min. braking resistor (Ω)
			10% braking	50% braking	80% braking	
GD20-0R4G-S2-EU	Built-in braking unit	361	0.06	0.30	0.48	42
GD20-0R7G-S2-EU		192	0.11	0.56	0.90	42
GD20-1R5G-S2-EU		96	0.23	1.10	1.80	30
GD20-2R2G-S2-EU		65	0.33	1.70	2.64	21
GD20-0R4G-2-EU		361	0.06	0.3	0.48	131
GD20-0R7G-2-EU		192	0.11	0.56	0.9	93
GD20-1R5G-2-EU		96	0.23	1.1	1.8	44
GD20-2R2G-2-EU		65	0.33	1.7	2.64	44
GD20-004G-2-EU		36	0.6	3	4.8	33
GD20-5R5G-2-EU		26	0.75	4.13	6.6	25
GD20-7R5G-2-EU		19	1.13	5.63	9	13
GD20-0R7G-4-EU		653	0.11	0.56	0.90	240

Model	Type of braking unit	Braking resistor at 100% of braking torque (Ω)	Consumed power of the braking resistor (kW)			Min. braking resistor (Ω)
			10% braking	50% braking	80% braking	
GD20-1R5G-4-EU		326	0.23	1.13	1.80	170
GD20-2R2G-4-EU		222	0.33	1.65	2.64	130
GD20-004G-4-EU		122	0.6	3	4.8	80
GD20-5R5G-4-EU		89.1	0.75	4.13	6.6	60
GD20-7R5G-4-EU		65.3	1.13	5.63	9	47
GD20-011G-4-EU		44.5	1.65	8.25	13.2	31
GD20-015G-4-EU		32.0	2.25	11.3	18	23
GD20-018G-4-EU		27	3	14	22	19
GD20-022G-4-EU		22	3	17	26	17
GD20-030G-4-EU		17	5	23	36	17
GD20-037G-4-EU		13	6	28	44	11.7
GD20-045G-4-B-EU		10	7	34	54	8
GD20-055G-4-B-EU		8	8	41	66	8
GD20-075G-4-B-EU		6.5	11	56	90	6.4
GD20-090G-4-B-EU		5.4	14	68	108	4.4
GD20-110G-4-B-EU		4.5	17	83	132	4.4

Note:

- ◇ Select the resistor and power of the braking unit according to the data our company provided.
- ◇ The braking resistor may increase the braking torque of the VFD. The resistor power in the above table is designed on 100% braking torque and 10% braking usage ratio. If the users need more braking torque, the braking resistor can decrease properly and the power needs to be magnified.

	◇ Never use a braking resistor with a resistance below the minimum value specified for the particular drive. The drive and the internal chopper are not able to handle the overcurrent caused by the low resistance.
	◇ Increase the power of the braking resistor properly in the frequent braking situation (the frequency usage ratio is more than 10%).

C.7.2 Braking resistor installation

Braking resistor cables need to be shielded cables.

Install all resistors in a place where they will cool.



- ⋄ The materials near the braking resistor must be non-flammable. The surface temperature of the resistor is high. Air flowing from the resistor is of hundreds of degrees Celsius. Protect the resistor against contact.

Goodrive20-EU series VFDs need only external braking resistors.

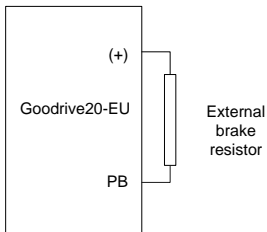

Appendix D Energy efficiency data

Table D-1 Power loss and IE class

Model	Relative loss (%)								Standby loss (W)	IE class
	(0;25)	(0;50)	(0;100)	(50;25)	(50;50)	(50;100)	(90;50)	(90;100)		
GD20-0R4G-S2-EU	2.00	2.00	2.41	1.90	1.70	2.10	1.20	2.10	5	IE2
GD20-0R7G-S2-EU	1.37	1.61	2.33	1.31	1.13	2.09	0.65	2.27	7	IE2
GD20-1R5G-S2-EU	1.17	1.47	2.20	1.00	1.27	1.94	0.93	2.61	8	IE2
GD20-2R2G-S2-EU	1.05	1.28	1.83	1.25	1.70	1.73	2.10	3.94	8	IE2
GD20-0R4G-2-EU	2.30	2.30	2.61	2.00	1.90	2.10	1.30	1.50	8	IE2
GD20-0R7G-2-EU	1.43	1.73	2.51	0.59	1.37	2.21	0.92	1.91	8	IE2
GD20-1R5G-2-EU	1.03	1.40	2.10	1.00	1.53	2.54	1.20	2.71	8	IE2
GD20-2R2G-2-EU	1.07	1.43	2.25	1.00	1.50	2.43	1.25	2.15	8	IE2
GD20-004G-2-EU	1.19	1.49	2.76	1.22	1.55	2.39	1.27	1.93	8	IE2
GD20-5R5G-2-EU	0.82	1.19	2.27	0.85	1.27	2.38	1.05	2.02	8	IE2
GD20-7R5G-2-EU	0.89	1.43	2.23	1.07	1.51	2.48	0.95	2.26	8	IE2
GD20-0R7G-4-EU	1.79	2.07	2.54	2.02	2.13	2.94	1.55	2.36	7	IE2
GD20-1R5G-4-EU	1.23	1.47	1.99	0.96	1.30	1.99	1.13	2.09	7	IE2
GD20-2R2G-4-EU	1.26	1.44	2.07	1.28	1.68	2.25	1.62	2.49	8	IE2
GD20-004G-4-EU	0.97	1.18	1.64	1.04	1.35	1.73	1.21	2.12	9	IE2
GD20-5R5G-4-EU	0.96	1.10	1.94	1.04	1.37	2.28	1.28	2.66	9	IE2
GD20-7R5G-4-EU	0.72	0.83	1.47	0.80	0.98	2.13	1.10	1.77	9	IE2
GD20-011G-4-EU	0.57	0.79	1.46	0.57	0.98	1.86	0.93	2.05	6	IE2
GD20-015G-4-EU	0.39	0.49	1.20	0.54	0.69	1.38	0.74	1.57	7	IE2
GD20-018G-4-EU	0.51	0.70	1.15	0.72	0.98	1.61	0.91	1.56	11	IE2
GD20-022G-4-EU	0.44	0.63	1.15	0.64	0.85	1.46	0.82	1.31	11	IE2
GD20-030G-4-EU	0.50	0.67	1.18	0.68	0.85	1.37	0.80	1.41	13	IE2
GD20-037G-4-EU	0.45	0.65	1.32	0.59	0.83	1.52	0.94	1.63	14	IE2
GD20-045G-4-EU	0.46	0.65	1.32	0.73	0.94	1.42	0.92	1.57	21	IE2
GD20-045G-4-B-EU	0.46	0.65	1.32	0.73	0.94	1.42	0.92	1.57	21	IE2
GD20-055G-4-EU	0.48	0.65	1.19	0.67	0.84	1.40	0.83	1.32	22	IE2
GD20-055G-4-B-EU	0.48	0.65	1.19	0.67	0.84	1.40	0.83	1.32	22	IE2
GD20-075G-4-EU	0.41	0.58	1.06	0.48	0.65	1.22	0.72	1.35	22	IE2
GD20-075G-4-B-EU	0.41	0.58	1.06	0.48	0.65	1.22	0.72	1.35	22	IE2
GD20-090G-4-EU	0.39	0.56	1.09	0.44	0.61	1.22	0.85	1.40	25	IE2
GD20-090G-4-B-EU	0.39	0.56	1.09	0.44	0.61	1.22	0.85	1.40	25	IE2
GD20-110G-4-EU	0.41	0.59	1.23	0.5	0.70	1.55	0.75	1.69	28	IE2
GD20-110G-4-B-EU	0.41	0.59	1.23	0.5	0.70	1.55	0.75	1.69	28	IE2

Table D-2 Rated specifications

Model	Apparent power (kVA)	Rated output power (kW)	Rated output current (A)	Max. working temperature (°C)	Rated power frequency (Hz)	Rated power voltage (V)		
GD20-0R4G-S2-EU	0.99	0.4	2.5	50°C Derate by 1% for every increase of 1°C when the temperature exceeds 40°C.	50Hz/60Hz Allowed range: 47-63Hz	1PH 230V		
GD20-0R7G-S2-EU	1.67	0.75	4.2					
GD20-1R5G-S2-EU	2.98	1.5	7.5					
GD20-2R2G-S2-EU	3.98	2.2	10					
GD20-0R4G-2-EU	0.99	0.4	2.5			50°C Derate by 1% for every increase of 1°C when the temperature exceeds 40°C.	50Hz/60Hz Allowed range: 47-63Hz	3PH 230V
GD20-0R7G-2-EU	1.67	0.75	4.2					
GD20-1R5G-2-EU	2.98	1.5	7.5					
GD20-2R2G-2-EU	3.98	2.2	10					
GD20-004G-2-EU	6.37	4	16					
GD20-5R5G-2-EU	7.96	5.5	20					
GD20-7R5G-2-EU	11.95	7.5	30					
GD20-0R7G-4-EU	1.73	0.75	2.5					
GD20-1R5G-4-EU	2.90	1.5	4.2					
GD20-2R2G-4-EU	3.81	2.2	5.5					
GD20-004G-4-EU	6.58	4	9.5					
GD20-5R5G-4-EU	9.69	5.5	14					
GD20-7R5G-4-EU	12.81	7.5	18.5					
GD20-011G-4-EU	17.32	11	25					
GD20-015G-4-EU	22.17	15	32					
GD20-018G-4-EU	26.32	18.5	38					
GD20-022G-4-EU	31.17	22	45					
GD20-030G-4-EU	41.56	30	60					
GD20-037G-4-EU	51.96	37	75					
GD20-045G-4-EU	63.73	45	92					
GD20-045G-4-B-EU	63.73	45	92					
GD20-055G-4-EU	79.67	55	115					
GD20-055G-4-B-EU	79.67	55	115					
GD20-075G-4-EU	103.92	75	150					
GD20-075G-4-B-EU	103.92	75	150					
GD20-090G-4-EU	124.70	90	180					
GD20-090G-4-B-EU	124.70	90	180					
GD20-110G-4-EU	148.95	110	215					
GD20-110G-4-B-EU	148.95	110	215					

Appendix E Further information

D.1 Product and service inquiries

Should you have any queries about the product, contact the local INVT office. Provide the model and serial number of the product you query about. You can visit www.esco-antriebstechnik.de/EN.

D.2 Feedback on INVT VFD manuals

Your comments on our manuals are welcome. Visit www.esco-antriebstechnik.de/EN. directly contact online service personnel or choose **Contact Us** to obtain contact information.

D.3 Documents on the Internet

You can find manuals and other product documents in PDF format on the Internet. Visit www.esco-antriebstechnik.de/EN and choose **Support > Download**.

Subject to technical changes.

Stand 09/2023

V2.1



esco antriebstechnik gmbh · Biberweg 10 · D-53842 Troisdorf

Tel. +49 (0) 2241 4807-0 · Fax. +49 (0) 2241 4807-10

E-Mail: info@esco-antriebstechnik.com · Internet: www.esco-antriebstechnik.de